



STRUC



since 1573

Kovačija Muta

a company of STRUC Holding

MADE IN SLOVENIA

STRUC Kovačija Muta d.o.o.

since 1573





TRADICIJA STOLETIJ
JAHRHUNDERTLANGE TRADITION
CENTURIES OF TRADITION

TRADICIJA KOVAŠTVA OD 1573 UPORABA KAKOVOSTNIH MATERIALOV ZAVEZA H KVALITETI, KI VZBUJA ZAUPANJE

STRUC Kovačija d.o.o. je del STRUC Holding GmbH

STRUC Holding je srednje velika, družinsko vodena skupina podjetij, ki deluje na številnih področjih v Sloveniji in Nemčiji. Naše glavno področje je proizvodnja kmetijskega, gradbenega in vrtnega orodja kot tudi industrijskih odkovkov in izdelkov iz pločevine. Poleg tega smo v Nemčiji prisotni na dveh lokacijah s proizvodnjo specialnih strojev kot tudi s proizvodnjo oken iz umetne mase. Naša moč je v raznolikosti.

SCHMIEDETRADITION SEIT 1573 HOCHWERTIGE MATERIALIEN IM EINSATZ QUALITÄTSBEWUSSTEIN; DASS VERTRAUEN SCHENKT

STRUC Kovačija ist ein Unternehmen der STRUC Holding GmbH.

Die STRUC Holding ist eine familiengeführte, mittelständische Unternehmensgruppe, die in mehreren Branchen in Slowenien und Deutschland tätig ist. Unser Hauptsegment liegt in der Herstellung von landwirtschaftlichen Werkzeugen, Bau- und Gartengeräten sowie industriellen Schmiedeteilen und Blecherzeugnissen. Darüber hinaus sind wir mit zwei Standorten in Deutschland auch in den Bereichen Sondermaschinenbau und Kunststofffensterfabrikation vertreten. Vielfalt ist unsere Stärke!

TRADITION SINCE 1573 MATERIALS OF HIGH QUALITY IN USE A QUALITY CONSCIOUSNESS WHICH PROVIDES CONFIDENCE

STRUC Kovačija is a company of the STRUC Holding GmbH.

The STRUC holding is a family-run, medium-sized group of companies which operates in various sectors in Slovenia and Germany. In Slovenia, we produce mainly agricultural-, contractors- and gardening tools as well as industrial forgings and sheet metals. Furthermore, we have got two more locations in Germany where we produce special purpose machines, production lines and PVC windows. We offer a huge range of products which makes our companies so successful.



STRUC Holding



- STRUC Kovačija Muta d.o.o.
 - STRUC MUTA, kmetijska mehanizacija d.o.o.
 - STRUC Ekoing d.o.o.
 - STRUC Tovarna Kos in srpov d.o.o.
 - STRUC Bukev d.o.o.
 - STRUC Tokos d.o.o.
 - Ketterer Technologies GmbH
 - STRUC Kunststoff fensterfabrikations GmbH
- www.struc.info



Mr. Vitomir Štruc, Managing Director of Struc Kovačija Muta



Zagotavljamo Vam najboljšo kakovost in strokovno izdelavo naših izdelkov.

Wir garantieren Ihnen beste Qualität und saubere Verarbeitung unserer Produkte.

Best quality and accurate processing of our products are taken for granted.

STRUC KOVAČIJA MUTA

Tradicija, funkcionalnost in sodobnost.

Železarstvo na Muti je obstajalo že leta 1573. Osnovni pogoji za njegov razvoj so bili bogati pohorski gozdovi, vodna sila in nahajališča železove rude.

V svoji zgodovini je tovarna na Muti zamenjala več lastnikov, svoj največji razcvet pa doživlja danes, ko postaja na domačem in tujem tržišču vedno bolj znana kot proizvajalka poljedelskega, vrtnega in cvetličnega orodja.

Izdelki, ki prihajajo iz tovarne Muta se ponašajo s skrbnostjo izdelave in kakovostjo, ki sta slavo tovarne vzdrževala skozi pretekla 4 stoletja, obenem pa so plod znanja in raziskovalnega dela strokovnjakov tovarne.

STRUC KOVAČIJA MUTA

Tradition und Gegenwart.

Alte Urkunden belegen, dass im bereits im Jahr 1573 Eisenhütten in Muta angesiedelt waren. Die Entstehung und die spätere Entwicklung der Eisenindustrie war möglich, weil die Gegend reich an Eisenerz, Holz und Wasser war.

In seiner langen Geschichte hat das Werk in Muta mehrmals den Eigentümer gewechselt, Höhen und Tiefen erlebt. Heute ist STRUC Kovačija in Muta, auf dem heimischen und dem internationalen Markt, ein angesehener Gerätehersteller für Gartenbedarf und Landwirtschaft.

STRUC Kovačija Muta ist seit ehedem bekannt für die erstklassige Qualität und sorgfältige Ausarbeitung aller Erzeugnisse. Motivierte Fachleute sorgen für die Weiterentwicklung der bewährten Geräte und die Entwicklung neuer Modelle.

STRUC KOVAČIJA MUTA

Ironworking in the past and nowadays.

Muta has been holding tradition in ironworks since 1573. Its progress has been essentially based upon rich woods of Pohorje, abundant water power and iron deposits.

In the past the ironworks at Muta changed many owners. Today the Muta factory is experiencing its golden age and getting more and more known by launching its products - agricultural and garden tools - to the home and foreign markets.

The products of Muta take pride upon their workmanship and prime quality that has maintained the good reputation of the factory for the last four centuries. At the same time they are the result of knowledge and research work of Muta specialist.

Znotraj podjetja STRUC Kovačija Muta d.o.o. deluje naše hčerinsko podjetje STRUC Ekoing d.o.o.. Poleg izdelave invalidskih stolov in vrtnih vozičkov je osnovna dejavnost podjetja izvajanje storitev kot so montaža, varjenje, nasajevanje, etiketiranje, pakiranje,... za STRUC Kovačijo Muta, kot tudi za druga podjetja. Cilj podjetja je ohraniti obstoječe delo, posodobiti tehnološke procese, ter iskanje in izvajanje novih programov in storitev.

Die STRUC Ekoing d.o.o. ist eine Tochtergesellschaft der STRUC Kovačija Muta d.o.o.. Neben der Herstellung von Schubkarren und Sitzhilfen für den Industriebedarf ist die Haupttätigkeit der STRUC Ekoing d.o.o. der Dienstleistungsbereich, wie z.B. Montagearbeiten, Schweißen, Etikettierung und Verpackung für die STRUC Kovačija als auch für externe Kunden.

Ziel ist die Bestandswahrung, die Optimierung der Prozesse sowie die Entwicklung neuer Programme und Dienstleistungen.

Inside of STRUC Kovačija Muta d.o.o. operate our on-site subsidiary company STRUC Ekoing d.o.o.. Company is occupied with production of invalid chairs and garden carts. Main activity of STRUC Ekoing are services like assembling, welding, handle assembling, labelling, packing,... for STRUC Kovačija Muta and other companies. Company purpose is to preserve existent work, to modernize technological processes, searching and performing new programmes and services.





PREVERILI SMO TRAJNOST IN
VZDRŽLJIVOST NAŠIH IZDELKOV

VON UNS AUF LANGLEBIGKEIT
UND ROBUSTHEIT GEPRÜFT

LONGEVITY AND
ROBUSTENESS ARE CERTIFIED



VILE, PIRUNI IN KOPAČI

vile za seno, gnoj, krompir, kamen,...
piruni, kopači za gnoj, kopači iz piruna,...

GABELN, SPATENGABELN UND HACKEN

Heugabeln, Dunggabeln,
Kartoffelgabeln, Steingabeln,...
Spatengabeln, Dunghacken,
Spatenhacken,...



FORKS, DIGGING FORKS AND CROCKS

hay forks, manure forks, potato forks, stone forks,...
digging forks, manure crocks, garden crocks,...





LOPATA STRUC KOVAČIJA MUTA
JE TRAJNA

SCHAUFELN VON KOVAČIJA MUTA
HÄLT DURCH

SHOVELS OF KOVAČIJA MUTA
STAYS THE COURSE



VALJANE IN PLOČEVINASTE LOPATE

lopate bavarske, lopate
hlevske, lopate za pesek,...



GEWALZTE SCHAUFELN UND SCHAUFELN AUS BLECH

Bayerische Schaufeln,
Randschaufeln, Hollsteiner
Schaufeln,...



ROLLED AND SHEET METAL SHOVELS

shovels bavaria, stable shovels,
sand shovels,...



ZAHTEVNO DELO POTREBUJE
KAKOVOSTNO ORODJE

GUTE ARBEIT
BRAUCHT GUTES WERKZEUG

GOOD TOOLS FOR GOOD WORK

ŠTEVILNI MODELI MOTIK

VERSCHIEDENE HACKENMODELLE

VARIOUS HOE TYPES





Z NAŠIM ORODJEM GRE LAŽJE

MIT UNSEREN WERKZEUG GEHT
ES LEICHTER

WITH OUR TOOLS IT'S EASIER
TO WORK



GRABLJE ZA RAZLIČNE NAMENE

vrtna, cestarske, grablje za asfalt,...

RECHEN FÜR VERSCHIEDENE ZWECKE

Gartenrechen, Straßenrechen,
Teerrechen,...



RAKES FOR DIFFERENT PURPOSES

garden rakes, road rakes,
asphalt rakes,...





NAKUP NAŠEGA ORODJA
JE DOBRA ODLOČITEV

DER KAUF UNSERER WERKZEUGE
IST EINE GUTE ENTSCHEIDUNG

BUYING OUR TOOLS IS A GOOD
DECISION



LOPATE ZA SNEG IN STRGALA

snežne lopate Alu-9, Alu-7, Alu-400,...



SCHNEESCHAUFELN UND STOßSCHARREN

Schneeschaufeln Alu-9, Alu-7, Alu-400,...

SNOW SHOVELS AND ICE SCRAPERS

snow shovels Alu-9, Alu-7, Alu-400,...



TRADICIJA STOLETIJ
JAHRHUNDERTLANGE TRADITION
CENTURIES OF TRADITION

STRUC KOVAČIJA MUTA d.o.o.
A COMPANY OF STRUC HOLDING



www.struc.info

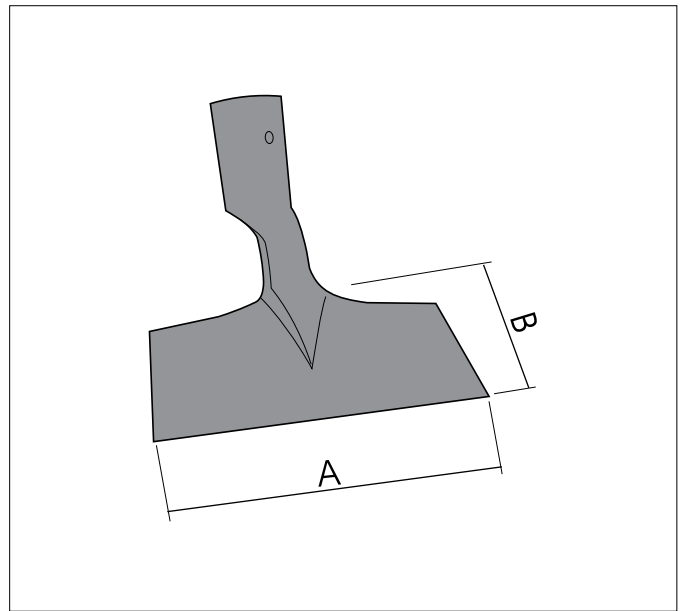
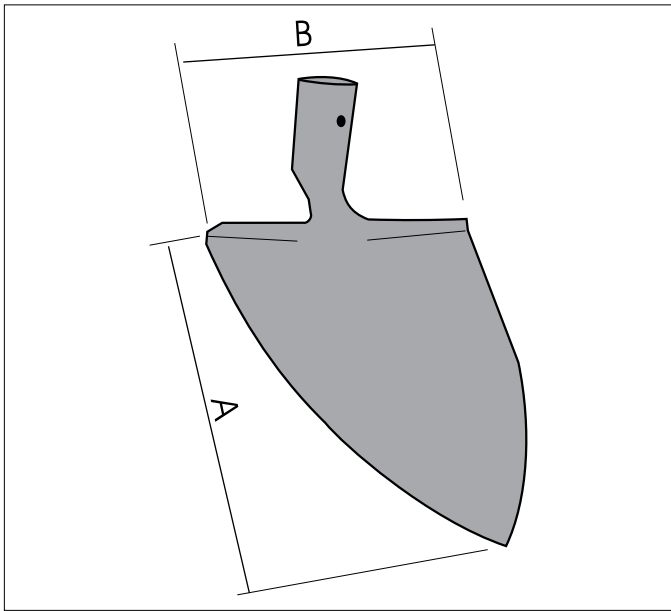
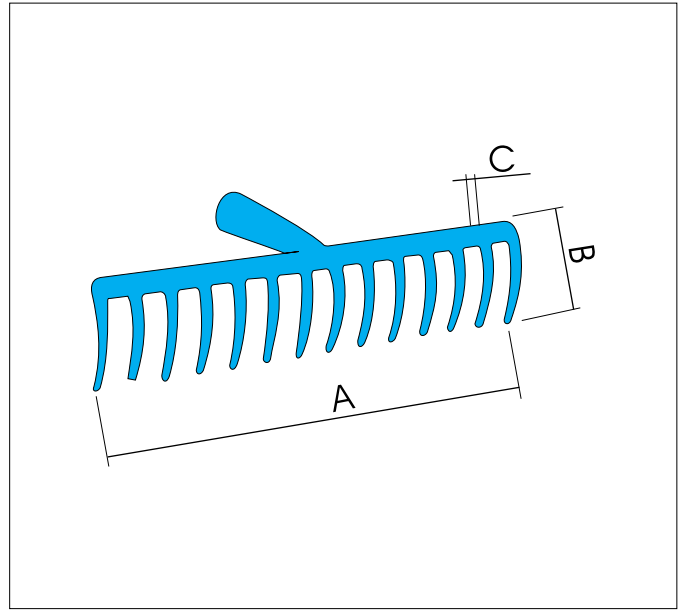
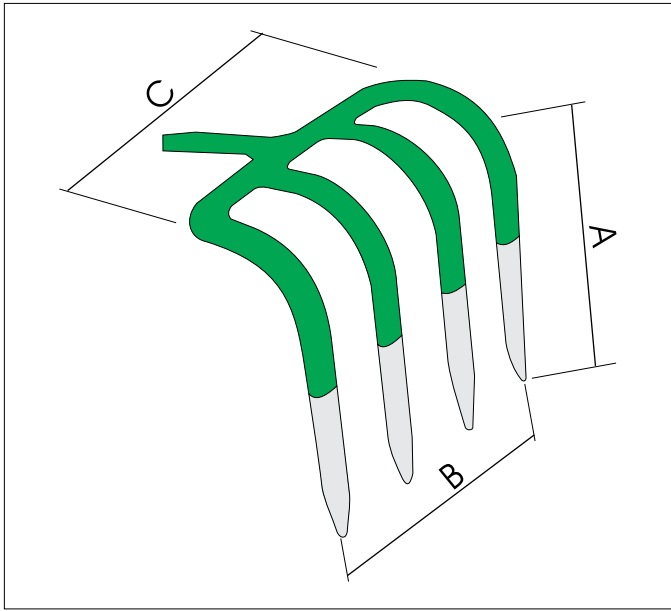
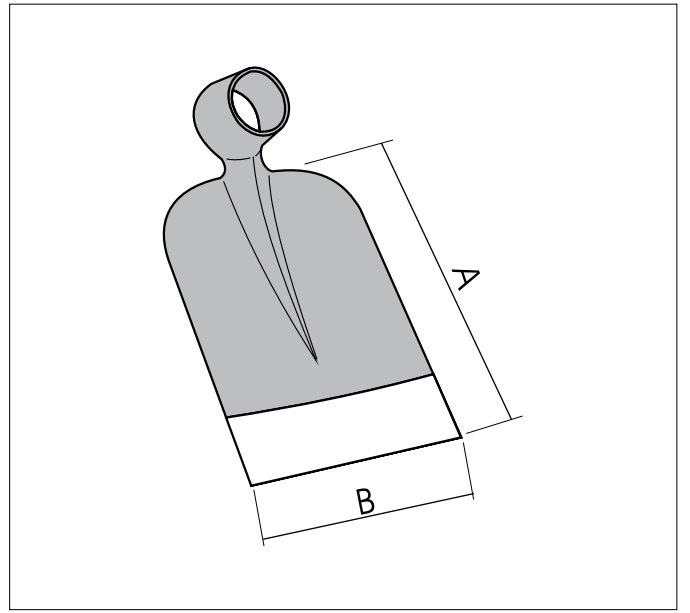
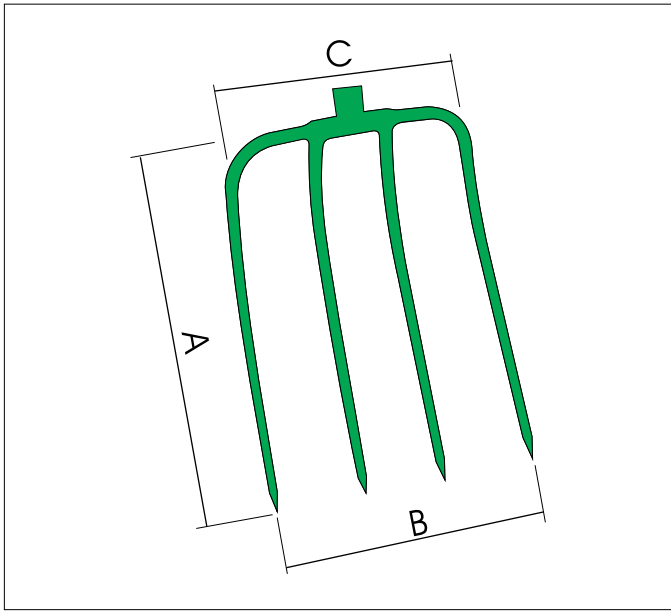



VILE, PIRUNI IN KOPAČI
GABELN, SPATENGABELN UND HACKEN
FORKS, DIGGING FORKS AND CROCKS



VILE ZA SNOPE 2R
BALLENGABEL 2 ZINKEN

BALE FORK 2 PRONGS
FOURCHE R BALLOT 2 DENTS

	Art. No.	(AxBxC)			<i>i</i>
	776 471	250 x 150 x 130	0,40	-	-
	758 767	280 x 150 x 130	0,45	-	-
	716 117	310 x 160 x 130	0,45	-	-
	763 986	310 x 160 x 130	0,45	-	-
	752 833	250 x 150 x 130	1,30	1300	-
	752 832	310 x 160 x 130	1,45	1300	-
	758 674	240 x 160 x 130	0,30	-	-
	776 312	250 x 150 x 130	0,30	-	-
	758 752	250 x 150 x 130	0,30	-	-
	758 794	260 x 150 x 130	0,40	-	-
	758 675	280 x 150 x 130	0,35	-	-
	776 308	310 x 160 x 130	0,40	-	-
	776 315	250 x 150 x 130	1,25	1350	-
	776 313	250 x 150 x 130	1,00	T850	-
	776 311	310 x 160 x 130	1,35	1350	-
	776 309	310 x 160 x 130	1,10	T850	-
	762 341	240 x 160 x 130	1,25	1350	-

VILE ZA SENO S PROTIROGLOM
HEUGABEL MIT GEGENZINKEN

HAY FORK
FOURCHE A FOIN

	Art. No.	(AxBxC)			<i>i</i>
	716 128	300 x 220 x 165	0,60	-	-
	752 837	300 x 220 x 165	1,50	1300	-
	776 328	300 x 220 x 165	0,50	-	-
	776 332	380 x 300 x 205	0,55	-	-
	776 331	300 x 220 x 165	1,45	1350	-
	776 329	300 x 220 x 165	1,20	T850	-
	776 335	380 x 300 x 205	1,50	1350	-
	776 333	380 x 300 x 205	1,25	T850	-
	716 129	380 x 300 x 205	0,65	-	-
	752 838	380 x 300 x 205	1,55	1300	-

VILE ZA GNOJ 3 R
DUNGGABEL 3 ZINKEN

MANURE FORK 3 PRONGS
FOURCHE A FUMIER 3 DENTS

	Art. No.	(AxBxC)			<i>i</i>
	758 792	280 x 220 x 190	0,60	-	-
	716 126	300 x 230 x 190	0,55	-	-
	716 121	300 x 230 x 190	0,65	1300	-
	752 839	300 x 230 x 190	1,55	1300	-
	758 770	280 x 220 x 190	0,50	-	-
	776 303	300 x 230 x 190	0,50	-	-
	776307	300 x 230 x 190	1,45	1350	-
	755 663	300 x 230 x 190	0,65	-	-

VILE ZA SENO 3 R
HEUGABEL 3 ZINKEN

HAY FORK 3 PRONGS
FOURCHE A FOIN 3 DENTS

	Art. No.	(AxBxC)			<i>i</i>
	776 472	260 x 200 x 165	0,50	-	-
	776 477	280 x 210 x 165	0,55	-	-
	716 124	300 x 220 x 165	0,60	-	-
	754 472	300 x 300 x 240	0,65	-	-
	752 835	260 x 200 x 165	1,40	1300	-
	752 834	280 x 210 x 165	1,45	1300	-
	779 773	300 x 220 x 165	1,50	1300	-
		776 473	260 x 200 x 165	0,45	-
759 887		280 x 190 x 135	0,46	-	-
776 478		280 x 210 x 165	0,50	-	-
776 316		300 x 220 x 165	0,50	-	-
776 320		300 x 180 x 165	0,50	-	-
776 353		300 x 300 x 240	0,50	-	-
763 028		310 x 280 x 200	0,60	-	-
762 305		340 x 320 x 295	0,60	-	-
776 342		370 x 280 x 205	0,55	-	-
776 385		300 x 300 x 240	1,45	1350	-
776 383		300 x 300 x 240	1,20	T850	-
776 476		260 x 200 x 165	1,40	1350	-
776 481		280 x 210 x 165	1,45	1350	-
776 319		300 x 220 x 165	1,45	1350	-
776 321		300 x 180 x 165	1,20	T850	-
762 225		300 x 300 x 240	1,60	1350	-
762 306		340 x 320 x 295	1,55	1350	-
776 327		370 x 280 x 205	1,50	1350	-
776 325		370 x 280 x 205	1,25	T850	-
		759 906	260 x 200 x 165	0,55	-
	776 482	300 x 300 x 240	0,65	-	-
	759 645	300 x 220 x 165	0,60	-	-
	763 029	310 x 280 x 200	0,65	-	-
	759 325	340 x 220 x 295	0,65	-	-
	716 127	370 x 280 x 205	0,65	-	-
	759 646	300 x 220 x 165	1,50	1300	-
	752 836	300 x 300 x 240	1,60	1300	-
	739 482	370 x 280 x 205	1,55	1300	-

VILE ZA KOMPOST 3 R
KLEIN KOMPOSTGABEL 3 ZINKEN

ROSE TREE FORK 3 PRONGS
FOURCHE A ROSIER 3 DENTS

	Art. No.	(AxBxC)			<i>i</i>
	758 986	170 x 85 x 75	0,30	-	-
	759 614	170 x 85 x 75	1,50	1350	-
	762 819	170 x 85 x 75	1,10	1200	-

VILE ZA KROMPIR 4 R
KARTOFFELGABEL 4 ZINKEN

POTATO FORK 4 PRONGS
FOURCHE A POMMES DE TERRE

	Art. No.	(AxBxC)			<i>i</i>
	759 598	310 x 230 x 210	0,80	-	-

VILE ZA GNOJ 4 R
DUNGGABEL 4 ZINKEN

MANURE FORK 4 PRONGS
FOURCHE À FUMIER 4 DENTS

	Art. No.	(AxBxC)			<i>i</i>
	776 486	280 x 220 x 185	0,70	-	-
	716 120	310 x 230 x 210	0,75	-	-
	748 066	310 x 230 x 210	0,75	-	-
	759 886	310 x 220 x 180	0,80	-	-
	716 133	310 x 230 x 185	0,75	-	-
	776 487	280 x 220 x 185	1,60	1300	-
	776 086	310 x 230 x 185	1,65	1300	-
	776 336	310 x 230 x 210	1,65	1300	-
	773 457	280 x 220 x 185	0,60	-	-
	776 490	310 x 230 x 185	0,65	-	-
	758 670	310 x 230 x 210	0,70	-	-
	773 459	310 x 230 x 210	0,65	-	-
	776 088	280 x 220 x 185	1,35	T850	-
	759 826	280 x 220 x 185	1,35	Dm850	-
	776 091	310 x 230 x 210	1,70	1350	-
	776 092	310 x 230 x 210	1,45	T850	-
	759 402	310 x 230 x 210	1,30	Pd850	-
	757 416	310 x 230 x 210	1,70	K1200	-
	757 414	310 x 230 x 210	1,35	Kt800	-
	757 415	310 x 230 x 210	1,35	Kd800	-
	763 038	310 x 230 x 210	1,60	1350	-
	776 492	310 x 230 x 185	1,60	1350	-
	776 491	310 x 230 x 185	1,40	T850	-
	713 891	280 x 220 x 185	0,75	-	-
	758 672	310 x 230 x 210	0,85	-	-
	758 768	310 x 230 x 210	0,75	-	-
	776 627	310 x 230 x 210	0,80	-	-
	776 628	280 x 220 x 185	1,65	1300	-
	753 297	310 x 230 x 210	2,15	1300	-
	758 196	310 x 230 x 210	1,05	-	-
	758 260	310 x 230 x 210	1,60	T850	-

VILE ZA KOMPOST 5 R
KOMPOSTGABEL 5 ZINKEN

COMPOST FORK 5 PRONGS
FOURCHE À COMPOST 5 DENTS

	Art. No.	(AxBxC)			<i>i</i>
	752 848	280 x 210 x 190	0,85	-	-
	752 849	280 x 210 x 190	1,75	1300	-
	763 046	270 x 210 x 190	0,75	-	-
	744 873	280 x 210 x 190	0,75	-	-
	739 973	280 x 210 x 190	1,70	1350	-
	759 656	280 x 210 x 190	1,45	T850	-
	752 850	280 x 210 x 190	1,65	T1100	-
	752 851	280 x 210 x 190	0,90	-	-
	752 852	280 x 210 x 190	1,80	1300	-

VILE ZA REPO 6R
RÜBENGABEL 6 ZINKEN

BETT FORK 6 PRONGS
FOURCHE À BETTE RAVES 6 DENTS

	Art. No.	(AxBxC)			<i>i</i>
	716 135	360 x 300 x 270	1,55	-	-
	752 853	360 x 300 x 270	2,45	1300	-
	763 089	360 x 300 x 270	1,45	-	-

VILE ZA KORUZO 6 R
MAISGABEL 6 ZINKEN

MAIZE FORK 6 PRONGS
FOURCHE À MAIS 6 DENTS

	Art. No.	(AxBxC)			<i>i</i>
	754 470	360 x 330 x 270	1,40	-	-
	754 471	360 x 330 x 270	1,30	-	-
	738 811	360 x 330 x 270	1,40	-	-
	752 854	360 x 330 x 270	2,30	1300	-

VILE ZA GNOJ 5 R
DUNGGABEL 5 ZINKEN

MANURE FORK 5 PRONGS
FOURCHE À FUMIER 5 DENTS

	Art. No.	(AxBxC)			<i>i</i>
	729 457	320 x 250 x 230	1,10	-	-
	716 151	320 x 250 x 230	1,10	-	-
	714 393	320 x 250 x 230	2,00	1300	-
	758 671	320 x 250 x 230	0,90	-	-
	776 134	320 x 250 x 230	0,95	-	-
	752 840	320 x 250 x 230	1,90	1350	-
	776 135	320 x 250 x 230	1,65	T850	-
	757 419	320 x 250 x 230	1,95	K1200	-
	757 417	320 x 250 x 230	1,60	Kt800	-
	757 418	320 x 250 x 230	1,60	Kd800	-
	752 846	320 x 250 x 230	1,15	-	-
	752 847	320 x 250 x 230	2,05	1300	-
	758 197	320 x 250 x 230	1,35	-	-
	758 261	320 x 250 x 230	2,05	T850	-

VILE ZA SILOS 6R
SILOGABEL 6 ZINKEN

ENSILAGE FORK 6 PRONGS
FOURCHE À ENSILAGE 6 DENTS

	Art. No.	(AxBxC)			<i>i</i>
	754 468	345 x 300 x 270	1,30	-	-
	754 469	345 x 300 x 270	1,20	-	-
	758 788	310 x 300 x 270	1,20	-	-
	739 324	345 x 300 x 270	1,35	-	-
	759 651	360 x 300 x 270	1,40	-	-
	752 855	345 x 300 x 270	2,25	1300	-



VILE ZA KAMEN 8 R
STEINGABEL 8 ZINKEN

STONE FORK 8 PRONGS
FOURCHE À CAILLOUX 8 DENTS

	Art. No.	(AxB)			<i>i</i>
	716 152	360 x 300	1,60	-	-
	752 856	360 x 300	2,50	1300	-



VILE ZA KROMPIR 8 R
KARTOFFELGABEL 8 ZINKEN

POTATO FORK 8 PRONGS
FOURCHE À POMMES DE TERRE 8 DENTS

Art. No.	(A x B)			<i>i</i>
748 068	360 x 300	1,60	-	-
752 857	360 x 300	2,50	1300	-



VILE ZA KROMPIR
KARTOFFELGABEL

POTATO FORK
FOURCHE À POMMES DE TERRE

Art. No.	(A x B x C)			<i>i</i>
757 912	400 x 320 x 295	1,70	-	-
758 041	400 x 320 x 295	2,60	1300	-



VILE ZA KROMPIR 9 R
KARTOFFELGABEL 9 ZINKEN

POTATO FORK 9 PRONGS
FOURCHE À POMMES DE TERRE 9 DENTS

Art. No.	(A x B)			<i>i</i>
759 674	360 x 270	1,90	-	-
759 664	360 x 270	2,70	Md850	-
716 811	360 x 270	1,80	-	-
763 771	320 x 280	1,95	-	-
748 069	360 x 270	1,95	-	-
752 858	360 x 270	2,85	1300	-



VILE ZA ODPADKE 20 ZOB
PFERDEGABEL 20 ZINKEN

SHAVING FORK 20 PRONGS
FOURCHE À ORDURE 20 DENTS

Art. No.	(A x B x C)			<i>i</i>
757 487	290 x 340 x 380	1,25	-	-
756 280	290 x 340 x 380	2,00	K1200	-
763 036	290 x 340 x 380	2,00	1500	-
763 751	290 x 340 x 380	2,00	1500	-

VILE ŽELEZNIČARŠKE 9 R
STEINGABEL 9 ZINKEN

STONE FORK 9 PRONGS
FOURCHE À CHEMIN DE FER 9 DENTS

Art. No.	(A x B)			<i>i</i>
739 866	350 x 280	1,75	-	-
752 860	350 x 280	2,65	1300	-
757 001	350 x 280	2,55	D770	-
716 803	350 x 280	1,65	-	-



VILE ZA GRAMOZ 9 R
STEINGABEL 9 ZINKEN

STONE FORK 9 PRONGS
FOURCHE À CALLIOUX 9 DENTS

Art. No.	(A x B)			<i>i</i>
738 299	330 x 240	1,90	-	-
752 859	330 x 240	2,80	1300	-
762 138	330 x 240	2,70	Md850	-
729 454	330 x 240	1,90	-	-
776 093	330 x 240	2,80	1300	-
759 873	330 x 240	2,60	T850	-

VILE ZA KOKS 12 R
KOKSGABEL 12 ZINKEN

COKE FORK 12 PRONGS
FOURCHE À CARBON 12 DENTS

Art. No.	(A x B)			<i>i</i>
729 161	470 x 400	3,30	-	-
752 863	470 x 400	4,20	1300	-

PIRUN CVETLIČNI
ROSENGABE

DIGGING FORK
FOURCHE À BÉCHER

Art. No.	(A x B)			<i>i</i>
758 793	300 x 140	0,80	-	-
763 017	300 x 140	0,65	-	-

PIRUN KARO
SPATENGABEL

GARDEN FORK
FOURCHE À BÉCHER

Art. No.	(A x B)			<i>i</i>
716 122	300 x 205	1,40	-	-
759 180	315 x 210	1,70	-	-
738 010	300 x 205	2,00	1000	-
762 353	300 x 205	2,35	1300	-

PIRUN
SPATENGABEL

DIGGING FORK
FOURCHE À BÉCHER

Art. No.	(A x B)			<i>i</i>
739 366	270 x 280	1,10	-	-
776 083	270 x 280	1,75	1000	-
762 354	270 x 280	2,00	1300	-
757 725	270 x 280	1,70	T850	-
777 084	270 x 280	1,70	D850	-
716 277	270 x 280	1,65	G850	-
754 544	300 x 190	1,50	-	ø38
762 156	300 x 190	1,50	-	ø36
758 021	310 x 185	1,70	-	ø40
759 017	300 x 190	2,30	1000	ø38
759 018	300 x 190	2,15	T850	ø38
762 327	310 x 185	2,50	1100	ø40
729 642	270 x 280	0,95	-	-
776 085	270 x 280	1,65	1000	-
757 726	270 x 280	1,65	T850	-
754 523	300 x 190	1,45	-	-
759 047	300 x 190	2,15	1000	-
758 166	300 x 190	2,05	T850	-
764 032	270 x 180	1,15	-	-
755 848	300 x 190	1,50	-	ø38
759 998	300 x 190	1,50	-	ø38
755 951	300 x 190	2,00	1000	ø40
758 167	300 x 190	2,05	T850	ø38

PIRUN Z DOLGO TULJAVO
SPATENGABEL MIT DOPPELFEDERDÜLLE

DIGGING FORK
FOURCHE À BÉCHER

Art. No.	(A x B)			<i>i</i>
758 472	270 x 180	1,25	-	-
758 470	300 x 190	1,75	-	-
758 475	270 x 180	1,80	T850	-
758 473	300 x 190	2,20	T850	-
759 600	300 x 190	2,50	LYD780	-

PIRUN Z DOLGO TULJAVO - RAZŠIRJEN
SPATENGABEL MIT DOPPELFEDERDÜLLE - LANZENZINKEN

DIGGING FORK
FOURCHE À BÉCHER

Art. No.	(A x B)			<i>i</i>
759 093	270 x 180	1,30	-	-
759 091	300 x 190	1,80	-	-

PIRUN VRTNI - RAZŠIRJEN
SPATENGABEL - LANZENZINKEN

DIGGING FORK WELDED
FOURCHE À BÉCHER

Art. No.	(A x B)			<i>i</i>
752 874	270 x 180	1,10	-	ø36
754 520	300 x 190	1,50	-	-
758 022	310 x 185	1,80	-	-
752 876	270 x 180	1,70	1000	ø36
757 727	270 x 180	1,65	T850	ø36
752 877	270 x 180	1,60	D850	ø36
762 582	310 x 185	2,60	1100	-
762 965	310 x 185	2,60	T915	-
744 418	270 x 180	0,95	-	-
754 514	300 x 190	1,50	-	-
752 886	270 x 180	1,70	1000	-
757 728	270 x 180	1,65	T850	-
752 887	270 x 180	1,65	D850	-
762 538	300 x 190	2,10	T850	-
759 136	270 x 180	1,10	-	ø38
759 161	300 x 190	1,55	-	-

KOPAČ MALI 3 R
GARTENHACKE 3 ZINKEN

GARDEN CROCK 3 PRONGS
CROC 3 DENTS

Art. No.	(A x B x C)			<i>i</i>
739 836	140 x 110 x 90	0,25	-	-
739 956	140 x 110 x 90	1,00	1350	-

KOPAČ ZA GNOJ 3 R
DUNGHACKE 3 ZINKEN

MANURE CROCK 3 PRONGS
CROC À FUMIER 3 DENTS

Art. No.	(A x B x C)			<i>i</i>
716 130	215 x 220 x 190	0,55	-	-
752 864	215 x 220 x 190	1,30	1300	-
763 047	270 x 210 x 190	0,50	-	-

KOPAČ ZA KROMPIR 4 R **POTATOES CROCK 4 PRONGS**
KARTOFFELHACKE 4 ZINKEN **CROC À POMMES DE TERRE 4 DENTS**

Art. No.	(AxBxC)	i	i	
			Art. No.	(AxBxC)
711 705	125 x 125 x 105	0,25	-	-
739 862	125 x 125 x 105	1,20	1350	-

KOPAČ ZA GNOJ 4 R **MANURE CROCK 4 PRONGS**
DUNGHACKE 4 ZINKEN **CROC À FUMIER 4 DENTS**

Art. No.	(AxBxC)	i	i	
			Art. No.	(AxBxC)
752 483	210 x 220 x 210	0,80	-	-
752 866	210 x 220 x 210	1,50	1300	-
757 255	210 x 220 x 210	0,65	-	-
762 343	210 x 220 x 210	1,50	1350	-
757 676	210 x 220 x 210	0,85	-	-

KOPAČ ZA GNOJ 4 R **MANURE CROCK 4 PRONGS**
DUNGHACKE 4 ZINKEN **CROC À FUMIER 4 DENTS**

Art. No.	(AxBxC)	i	i	
			Art. No.	(AxBxC)
716 131	210 x 210 x 185	0,70	-	-
776 079	210 x 210 x 185	1,50	1300	-
758 589	210 x 210 x 185	0,70	-	-
757 144	210 x 210 x 185	0,65	-	-
759 750	210 x 210 x 185	1,50	1350	-
757 657	210 x 210 x 185	0,75	-	-

KOPAČ ZA GNOJ 5 R **MANURE CROCK 5 PRONGS**
DUNGHACKE 5 ZINKEN **CROC À FUMIER 5 DENTS**

Art. No.	(AxBxC)	i	i	
			Art. No.	(AxBxC)
752 484	220 x 250 x 230	1,05	-	-
752 867	220 x 250 x 230	1,95	1300	-
757 256	220 x 250 x 230	1,00	-	-
757 946	220 x 250 x 230	1,25	-	-

KOPAČ ZA GNOJ Z BUNKICAMI 4 R **MANURE CROCK 4 PRONGS**
DUNGHACKE 4 ZINKEN **CROC À FUMIER 4 DENTS**

Art. No.	(AxBxC)	i	i	
			Art. No.	(AxBxC)
759 644	210 x 210 x 185	0,75	-	-

KOPAČ ZA GNOJ 6 R **MANURE CROCK 6 PRONGS**
DUNGHACKE 6 ZINKEN **CROC À FUMIER 6 DENTS**

Art. No.	(AxBxC)	i	i	
			Art. No.	(AxBxC)
756 629	215 x 285 x 275	1,50	-	-

KOPAČ IZ PIRUNA 4 R **GARDEN CROCK 4 PRONGS**
SPATENHACKE 4 ZINKEN **CROC DE FORCHE À BÉCHER 4 DENTS**

Art. No.	(AxBxC)	i	i	
			Art. No.	(AxBxC)
716 132	180 x 165 x 180	0,95	-	-
752 868	200 x 165 x 180	0,95	-	-
776 065	180 x 165 x 180	1,70	1100	-
752 869	200 x 165 x 180	1,70	1100	-
752 870	180 x 165 x 180	0,90	-	-
752 872	200 x 165 x 180	0,90	-	-
752 873	200 x 165 x 180	1,80	1200	-
716 132				
752 870				
752 868				
752 872				

KOPAČ IZ PIRUNA 4 R **GARDEN CROCK 4 PRONGS**
SPATENHACKE 4 ZINKEN **CROC DE FORCHE À BÉCHER 4 DENTS**

Art. No.	(AxBxC)	i	i	
			Art. No.	(AxBxC)
758 868	240 x 175 x 190	1,30	-	-



LOPATE
SCHAUFELN UND SPATEN
SHOVELS AND SPADES



LOPATA BAVARSKA
BAYERISCHE SANDSCHAUFEL

SAND SHOVEL "BAVARIA"
PELLE



Art. No.	(A x B)				<i>i</i>
713 783	280 x 280	1,10	-	-	
713 784	300 x 300	1,30	-	-	
757 042	280 x 280	1,10	-	-	
757 043	300 x 300	1,30	-	-	
714 303	280 x 280	2,10	1250	-	
714 302	300 x 300	2,30	1250	-	
757 044	280 x 280	2,30	1250	-	
757 045	300 x 300	2,30	1250	-	

LOPATA PREMOGOVNA
BLECHKOHELSCHAUFEL

COAL SHOVEL
PELLE



Art. No.	(A x B)				<i>i</i>
729 452	350 x 290	1,80	-	-	
777 491	350 x 290	2,80	1300	-	
716 154	350 x 290	2,80	D800	-	

LOPATA KONIČASTA
SPITZSCHAUFEL

SHOVEL POINTED
PELLE



Art. No.	(A x B)				<i>i</i>
748 076	285 x 275	1,30	-	-	
776 063	285 x 275	2,30	1250	-	

LOPATA PONVASTA
PFANNENSCHAUFEL

COAL SHOVEL
PELLE



Art. No.	(A x B)				<i>i</i>
716 077	365 x 365	2,20	-	10°	
773 495	365 x 365	2,20	-	30°	
754 345	400 x 400	3,20	1300	30°	
755 061	365 x 365	3,00	T540	30°	
755 062	365 x 365	3,20	T740	30°	

LOPATA OKROGLA
RUNDSCHAUFEL

SHOVEL ROUND
PELLE



Art. No.	(A x B)				<i>i</i>
748 077	230 x 245	1,30	-	-	
776 064	230 x 245	2,30	1250	-	

LOPATA PREMOGOVNA
RANDSCHAUFEL

COAL SHOVEL
PELLE



Art. No.	(A x B)				<i>i</i>
716 105	295 x 285	1,30	-	-	
754 344	295 x 285	2,30	1300	-	

LOPATA RUDARSKA ŠIROKA
ENGLISCHESCHAUFEL-BREIT

SOLID SOCKET SQUARE
PELLE



Art. No.	(A x B)				<i>i</i>
757 827	320 x 250	1,95	-	ø34	
757 828	320 x 250	1,95	-	ø32	
757 840	320 x 250	2,50	T700	ø34	
757 841	320 x 250	2,80	Md700	ø34	
757 842	320 x 250	2,75	MYD700	ø32	

LOPATA HLEVSKA
RANDSCHAUFEL

STABLE SHOVEL
PELLE



Art. No.	(A x B)				<i>i</i>
716 106	325 x 220	0,90	-	A	
716 107	350 x 232	1,00	-	B	
754 342	325 x 220	1,90	1300	A	
755 893	350 x 232	2,00	1300	B	

LOPATA RUDARSKA OZKA
ENGLISCHE SCHAUFEL-SCHMAL

SOLID SOCKET TAPER
PELLE



Art. No.	(A x B)				<i>i</i>
757 829	320 x 250	1,90	-	ø34	
757 830	320 x 250	1,90	-	ø32	
757 844	320 x 250	2,45	T700	ø34	
757 845	320 x 250	2,75	Md700	ø34	
757 846	320 x 250	2,75	MYD700	ø32	

LOPATA UNIVERZALNA
RANDSCHAUFEL

SHOVEL UNIVERSAL
PELLE



Art. No.	(A x B)				<i>i</i>
716 108	355 x 235	0,95	-	A	
716 109	370 x 260	1,05	-	B	
738 690	355 x 235	1,90	1300	A	
758 175	370 x 260	2,00	1300	B	

LOPATA ZA ZEMLJO
SCHAUFEL FÜR ERDE

SHOVEL FOR SOIL
PELLE



Art. No.	(AxB)			<i>i</i>
716 110	250 x 250	1,05	-	A
716 111	270 x 275	1,15	-	B
757 939	250 x 250	2,05	1300	A
754 343	270 x 275	2,15	1300	B

LOPATA PONVASTA 6 RAVNA
BLECHSCHAUFEL NR. 6

OPEN SOCKET SHOVEL NO. 6
PELLE



Art. No.	(AxB)			<i>i</i>
757 792	360 x 306	1,90	-	-
757 806	360 x 306	2,40	T680	-
757 807	360 x 306	2,35	Pd680	-

LOPATA METAČA "0", "00" & "000"
SCHAUFEL "0", "00" & "000"

SHOVEL "0", "00" & "000"
PELLE HOLLANDER "0", "00", "000"



Art. No.	(AxB)			<i>i</i>
756 507	270 x 220	0,88	-	0
756 505	260 x 215	0,85	-	00
756 504	260 x 215	0,80	-	000
759 159	260 x 215	0,80	-	000 1/4
757 535	205 x 168	0,42	-	-

LOPATA IRSKA
IRISCHE SCHAUFEL

IRISH ROUND MOUNTH SHOVEL
PELLE



Art. No.	(AxB)			<i>i</i>
757 963	360 x 206	1,50	-	-
757 962	360 x 206	2,65	1370	-

LOPATA ZA CENTRALNO KURJAVO
ZENTRALHEIZUNGSCHAUFEL

SHOVEL FOR CENTRAL HEATING
PELLE



Art. No.	(AxB)			<i>i</i>
716 161	340 x 200	1,05	-	-
777 155	340 x 200	1,80	Pd660	-

LOPATA METAČA 25
SCHAUFEL 25

SHOVEL 25
PELLE 25



Art. No.	(AxB)			<i>i</i>
759 333	290 x 260	1,30	-	-

LOPATA PONVASTA 2 RAVNA
BLECHSCHAUFEL NR. 2

OPEN SOCKET SHOVEL NO. 2
PELLE



Art. No.	(AxB)			<i>i</i>
757 790	325 x 250	1,45	-	-
757 800	325 x 250	1,90	T680	-
757 801	325 x 250	2,40	1200	-
757 802	325 x 250	1,90	Pd680	-

LOPATA METAČA 27
SCHAUFEL 27

SHOVEL 27
PELLE 27



Art. No.	(AxB)			<i>i</i>
759 334	275 x 275	1,15	-	-

LOPATA PONVASTA 4 RAVNA
BLECHSCHAUFEL NR. 4

OPEN SOCKET SHOVEL NO. 4
PELLE



Art. No.	(AxB)			<i>i</i>
757 791	335 x 275	1,60	-	-
757 803	335 x 275	2,10	T680	-
757 804	335 x 275	2,50	1200	-
757 805	335 x 275	2,05	Pd680	-

SMETIŠNICA
KEHRRICHTSCHAUFEL

HOUSEHOLD SHOVEL
PELLE



Art. No.	(AxB)			<i>i</i>
757 337	260 x 335	0,65	-	-
757 335	260 x 335	0,75	250	-
757 336	260 x 235	0,75	250	-

LOPATICA ZA PREMOG
KOHLEKELLE

COAL SHOVEL
PELLE



Art. No.	(A x B)			<i>i</i>
716 116	200 x 115	0,40	-	-
731 381	200 x 115	0,50	250	-

LOPATA PREKOPNA "BASALT"
SPATEN "BASALT"

SPADE "BASALT"
BÈCHE "BASALT"



Art. No.	(A x B)			<i>i</i>
737 843	285 x 180	1,30	-	-
739 504	285 x 180	2,00	T850	-
739 503	285 x 180	2,00	1000	-

LOPATA PREKOPNA KONIČASTA
SPATEN SPITZ

SPADE
BÈCHE



Art. No.	(A x B)			<i>i</i>
716 098	280 x 230	1,20	-	-
754 340	280 x 230	2,20	1000	-

LOPATA RAVNA
SPATEN

SPADE
BÈCHE



Art. No.	(A x B)			<i>i</i>
777 597	270 x 180	1,25	-	-
777 083	270 x 180	1,70	D850	-
777 598	270 x 180	1,65	T850	-
777 600	270 x 180	1,75	1000	-

LOPATA PREKOPNA HERKULES
SPATEN "HERKULES"

SPADE "HERKULES"
BÈCHE



Art. No.	(A x B)			<i>i</i>
716 095	290 x 200	1,30	-	-
754 341	290 x 200	2,30	1000	-

LOPATA SULIČASTA
SPATEN

TABULAR FENCING SPADE
BÈCHE



Art. No.	(A x B)			<i>i</i>
758 305	275 x 135	1,50	-	-
758 306	275 x 135	4,65	K1370	-

LOPATA PREKOPNA
SPATEN

SPADE
BÈCHE



Art. No.	(A x B)			<i>i</i>
729 448	300 x 230	0,90	-	-
716 157	300 x 230	1,50	1000	-
759 763	300 x 230	1,50	T850	-
729 447	300 x 230	1,50	D850	-

LOPATA PREKOPNA HIT
SPATEN HIT

SPADE "HIT"
BÈCHE "HIT"



Art. No.	(A x B)			<i>i</i>
755 495	245 x 162	1,04	-	0
739 580	270 x 180	1,20	-	1
752 844	245 x 162	1,70	T850	-
753 168	270 x 180	1,90	1000	-
755 497	270 x 180	1,85	T850	-
756 306	245 x 180	0,70	-	-
756 442	245 x 180	0,70	-	-

LOPATA PREKOPNA Z OBROČEM
SPATEN MIT RING

DIGING SHOVELS WITH RING
BÈCHE



Art. No.	(A x B)			<i>i</i>
716 100	265 x 265	1,15	-	-
759 326	265 x 265	1,75	1000	-

LOPATA VRTNA VALJANA ECCO - HOLLAND
ECCO-SPATEN - HOLLAND MODEL

GARDEN SPADE ECCO ROLLING - HOLLAND
PELLE



Art. No.	(A x B)			<i>i</i>
759 118	280 x 165	1,20	-	LAK
759 119	280 x 165	1,20	-	BRUSI/POLERT
759 060	280 x 165	2,00	T780	-
759 061	280 x 165	2,00	T780	-

LOPATA PREKOPNA SPATEN SPADE BÈCHE



Art. No.	(A x B)			<i>i</i>
758 088	200 x 138	1,45	-	-

LOPATA ZA PESEK - OKROGLA HOLLÄNDER SCHAUFEL SHOVEL "HOLLÄND" PELLE "HOLLÄND"



Art. No.	(A x B x C)			<i>i</i>
755 873	340 x 250 x 35°	1,30	-	2 1/2
739 526	340 x 250 x 45°	1,10	-	2 3/4
739 745	340 x 250 x 45°	2,10	1300	2 3/4

LOPATA PREKOPNA SPATEN SPADE BÈCHE



Art. No.	(A x B)			<i>i</i>
756 306	245 x 178	0,70	-	-
758 068	200 x 138	0,43	-	-

LOPATA PREKOPNA KONIČASTA FRANKFURTER SCHAUFEL SAND SHOVEL "FRANKFURTER" BÈCHE



Art. No.	(A x B)			<i>i</i>
739 527	300 x 270	1,10	-	-
739 746	300 x 270	2,10	1300	-

LOPATA METAČA AUFBUGSCHAUFEL SHOVEL FOR THROWING PELLE



Art. No.	(A x B)			<i>i</i>
729 446	350 x 270	1,10	-	-
758 257	350 x 270	1,10	-	PLITVA
716 155	350 x 270	2,10	1300	-
758 258	350 x 270	2,10	1300	PLITVA

LOPATA KONIČASTA BLECH SPITZSCHAUFEL POINTED SHOVEL PELLE



Art. No.	(A x B)			<i>i</i>
716 278	295 x 240	1,10	-	-
777 489	295 x 240	1,65	1000	-
776 061	295 x 240	1,65	T850	-
759 388	295 x 240	1,65	PD850	-

LOPATA RAVNA "0" "HOLSTEINER" SCHAUFEL "0" SHOVEL "HOLSTEIN" "0" PELLE



Art. No.	(A x B)			<i>i</i>
756 631	275 x 220	0,95	-	-

LOPATA "WEICHMACH" WEICHMACHER SPADE "WEICHMACH" PELLE



Art. No.	(A x B)			<i>i</i>
757 111	175 x 212	0,75	-	-

LOPATA ZA PESEK - RAVNA HOLSTEINER SCHAUFEL SHOVEL "HOLSTEIN" PELLE "HOLSTEIN"



Art. No.	(A x B)			<i>i</i>
754 085	245 x 230	1,00	-	2 1/2
739 525	245 x 230	1,00	-	2 3/4
759 302	245 x 230	1,15	-	2 3/4-0
754 111	260 x 240	1,15	-	3 1/2
754 110	260 x 240	1,15	-	3 3/4
739 744	245 x 230	2,00	1300	2 3/4
757 027	260 x 240	2,15	1300	3 3/4

LOPATA PREKOPNA KONIČASTA KABELGRABENSCHAUFEL SPADE BÈCHE



Art. No.	(A x B)			<i>i</i>
757 007	300 x 170	1,00	-	-





MOTIKE
HAUEN
HOES





**MOTIKA POSAVSKA
HAUE "POSAVSKA"**

**HOE "POSAVSKA"
HOUE "POSAVSKA"**

Art. No.	(AxB)			<i>i</i>
716 007	185 x 170	0,70	-	-
716 020	205 x 190	1,00	-	-
756 625	185 x 170	1,70	1200	-
756 626	205 x 190	1,70	1200	-



**MOTIKA TOBAČNA
HAUE "TOBAČNA"**

**HOE "TOBAČNA"
HOUE "TOBAČNA"**

Art. No.	(AxB)			<i>i</i>
716 058	160 x 135	0,25	-	-
754 346	160 x 135	0,80	1250	-



**ROVNICA SRBSKA
HAUE "SRBSKA"**

**HOE "SRBSKA"
HOUE "SRBSKA"**

Art. No.	(AxB)			<i>i</i>
716 024	205 x 100	1,60	-	-



**MOTIKA RUDARSKA
HAUE "RUDARSKA"**

**HOE "RUDARSKA"
HOUE "RUDARSKA"**

Art. No.	(AxB)			<i>i</i>
748 019	240 x 240	1,50	-	-

**MOTIKA BISTRIŠKA
HAUE "BISTRIŠKA"**

**HOE "BISTRIŠKA"
HOUE "BISTRIŠKA"**

Art. No.	(AxB)			<i>i</i>
773 470	190 x 220	1,00	-	-
754 352	190 x 220	1,70	1200	-



**MOTIKA CESTARSKA
HAUE "CESTARSKA"**

**HOE "CESTARSKA"
HOUE "CESTARSKA"**

Art. No.	(AxB)			<i>i</i>
748 020	390 x 120	1,50	-	-



**MOTIKA ŠTAJERSKA
HAUE "ŠTAJERSKA"**

**HOE "ŠTAJERSKA"
HOUE "ŠTAJERSKA"**

Art. No.	(AxB)			<i>i</i>
716 050	190 x 170	0,40	-	-
716 052	230 x 210	0,60	-	-
713 647	190 x 170	0,90	1200	-
713 965	230 x 210	1,10	1200	-

**ROVNICA MADŽARSKA
HAUE "MADŽARSKA"**

**HOE "MADŽARSKA"
HOUE "MADŽARSKA"**

Art. No.	(AxB)			<i>i</i>
716 022	160 x 120	1,20	-	-
754 353	160 x 120	2,20	1100	-



**MOTIKA DOLENJSKA
HAUE "DOLENJSKA"**

**HOE "DOLENJSKA"
HOUE "DOLENJSKA"**

Art. No.	(AxB)			<i>i</i>
716 016	185 x 165	0,55	-	-
748 047	220 x 210	1,10	-	-
716 017	200 x 190	0,70	-	-
738 306	200 x 190	1,70	1200	-

**MOTIKA MADŽARSKA 1
HAUE "MADŽARSKA" 1**

**HOE "MADŽARSKA" 1
HOUE "MADŽARSKA" 1**

Art. No.	(AxB)			<i>i</i>
759 796	325 x 115	0,90	-	-

MOTIKA MADŽARSKA 2
HAUE "MADŽARSKA" 2

HOE "MADŽARSKA" 2
HOUE "MADŽARSKA" 2



Art. No.	(A x B)				<i>i</i>
759 797	115 x 115	0,25	-	-	-

MOTIKA SMEDEREVSKA
HAUE "SMEDEREVSKA"

HOE "SMEDEREVSKA"
HOUE "SMEDEREVSKA"



Art. No.	(A x B)				<i>i</i>
716 012	165 x 290	1,00	-	-	-

MOTIKA MADŽARSKA 3
HAUE "MADŽARSKA" 3

HOE "MADŽARSKA" 3
HOUE "MADŽARSKA" 3



Art. No.	(A x B)				<i>i</i>
759 798	220 x 195	0,90	-	-	-

ROVNICA POŽAREVAČKA
HAUE "POŽAREVAČKA"

HOE "POŽAREVAČKA"
HOUE "POŽAREVAČKA"



Art. No.	(A x B)				<i>i</i>
716 013	150 x 330	1,00	-	-	-

MOTIKA NEMŠKA RUDARSKA
SPITZKRATZE

GERMAN HOE
HOUE



Art. No.	(A x B)				<i>i</i>
716 023	250 x 200	1,30	-	-	-

MOTIKA ŠABAČKA
HAUE "ŠABAČKA"

HOE "ŠABAČKA"
HOUE "ŠABAČKA"



Art. No.	(A x B)				<i>i</i>
716 010	190 x 250	0,80	-	-	-

MOTIKA "SCHWANBERG"
SCHWANBERGER HAUE

HOE "SCHWANBERG"
HOUE "SCHEANBERG"



Art. No.	(A x B)				<i>i</i>
755 603	180 x 160	0,30	-	-	-
755 604	190 x 170	0,40	-	-	-
755 605	200 x 190	0,50	-	-	-
755 606	220 x 200	0,60	-	-	-
757 942	180 x 160	0,90	1250	-	-
757 943	190 x 170	1,00	1250	-	-
757 944	200 x 190	1,10	1250	-	-
757 945	220 x 200	1,20	1250	-	-

MOTIKA GORNJE MILANOVAČKA
HAUE "GORNJE MILANOVAČKA"

HOE "GORNJE MILANOVAČKA"
HOUE "GORNJE MILANOVAČKA"



Art. No.	(A x B)				<i>i</i>
716 009	160 x 240	0,90	-	-	-

MOTIKA KONGO
HAUE "KONGO"

HOE "KONGO"
HOUE "KONGO"



Art. No.	(A x B)				<i>i</i>
776 281	220 x 160	1,13	-	-	-
757 353	220 x 160	1,85	1200	-	-



MOTIKA UŽIČKA
HAUE "UŽIČKA"

HOE "UŽIČKA"
HOUE "UŽIČKA"





Art. No.	(A x B)				<i>i</i>
716 030	195 x 220	0,80	-	-	-

MOTIKA PEČSKA
HAUE "PEČSKA" HOE "PEČSKA"
HOUE "PEČSKA"

Art. No.	(AxB)	HOE "PEČSKA"		
				<i>i</i>
748 013	200 x 290	1,00	-	-





MOTIKA STUPIŠKA
HAUE "STUPIŠKA" HOE "STUPIŠKA"
HOUE "STUPIŠKA"

Art. No.	(AxB)	HOE "STUPIŠKA"		
				<i>i</i>
748 041	150 x 220	1,00	-	-
756 621	150 x 220	1,70	1200	-



MOTIKA KOČANSKA
HAUE "KOČANSKA" HOE "KOČANSKA"
HOUE "KOČANSKA"

Art. No.	(AxB)	HOE "KOČANSKA"		
				<i>i</i>
716 019	200 x 265	1,20	-	-
756 627	200 x 265	2,10	-	-





MOTIKA ZELINSKA
HAUE "ZELINSKA" HOE "ZELINSKA"
HOUE "ZELINSKA"

Art. No.	(AxB)	HOE "ZELINSKA"		
				<i>i</i>
748 022	180 x 235	1,20	-	-





MOTIKA SKOPSKA
HAUE "SKOPSKA" HOE "SKOPSKA"
HOUE "SKOPSKA"

Art. No.	(AxB)	HOE "SKOPSKA"		
				<i>i</i>
716 014	190 x 245	1,20	-	-
716 015	200 x 265	1,40	-	-
754 354	190 x 245	2,20	1200	-





MOTIKA GRANIČARSKA
HAUE "GRANIČARSKA" HOE "GRANIČARSKA"
HOUE "GRANIČARSKA"

Art. No.	(AxB)	HOE "GRANIČARSKA"		
				<i>i</i>
716 006	170 x 210	0,90	-	-
756 623	170 x 210	1,70	-	-





MOTIKA BITOLSKA
HAUE "BITOLSKA" HOE "BITOLSKA"
HOUE "BITOLSKA"

Art. No.	(AxB)	HOE "BITOLSKA"		
				<i>i</i>
716 003	180 x 180	0,50	-	-
716 011	195 x 200	0,70	-	-
716 040	220 x 240	1,00	-	-
756 619	180 x 180	1,50	1300	-
754 347	195 x 200	1,70	1300	-



MOTIKA LIŠKA
HAUE "LIŠKA" HOE "LIŠKA"
HOUE "LIŠKA"

Art. No.	(AxB)	HOE "LIŠKA"		
				<i>i</i>
748 043	150 x 220	1,00	-	-





MOTIKA TOPLIŠKA
HAUE "TOPLIŠKA" HOE "TOPLIŠKA"
HOUE "TOPLIŠKA"

Art. No.	(AxB)	HOE "TOPLIŠKA"		
				<i>i</i>
716 043	190 x 260	0,80	-	-



MOTIKA BIHAČKA
HAUE BIHAČKA HOE "BIHAČKA"
HOUE "BIHAČKA"

Art. No.	(AxB)	HOE "BIHAČKA"		
				<i>i</i>
716 049	140 x 270	0,80	-	-



MOTIKA BOSANSKA
HAUE "BOSANSKA"

HOE "BOSANSKA"
HOUE "BOSANSKA"



Art. No.	(A x B)			<i>i</i>
716 008	140 x 280	0,70	-	-

MOTIKA GROTSKA
HAUE "GROTSKA"

HOE "GROTSKA"
HOUE "GROTSKA"



Art. No.	(A x B)			<i>i</i>
748 033	190 x 265	0,80	-	-
754 351	190 x 265	1,80	1200	-

MOTIKA FOČANSKA
HAUE "FOČANSKA"

HOE "FOČANSKA"
HOUE "FOČANSKA"



Art. No.	(A x B)			<i>i</i>
716 001	220 x 210	0,80	-	-

MOTIČICA TOBAČNA OKROGLA
HAUE "TOBAČNA OKROGLA"

HOE "TOBAČNA OKROGLA"
HOUE "TOBAČNA OKROGLA"



Art. No.	(A x B)			<i>i</i>
716 059	120 x 150	0,30	-	-
756 620	120 x 150	0,80	-	-

MOTIKA NIKŠIČKA
HAUE "NIKŠIČKA"

HOE "NIKŠIČKA"
HOUE "NIKŠIČKA"



Art. No.	(A x B)			<i>i</i>
716 002	195 x 250	1,00	-	-
737 956	195 x 200	2,00	1200	-

MOTIKA KUTINSKA
HAUE "KUTINSKA"

HOE "KUTINSKA"
HOUE "KUTINSKA"



Art. No.	(A x B)			<i>i</i>
716 005	150 x 300	0,90	-	-
756 624	150 x 300	1,70	-	-

MOTIKA LJUTOMERSKA
HAUE "LJUTOMERSKA"

HOE "LJUTOMERSKA"
HOUE "LJUTOMERSKA"



Art. No.	(A x B)			<i>i</i>
716 053	290 x 260	1,40	-	-
756 575	290 x 260	2,40	1200	-

MOTIKA PRISTAVSKA
HAUE "PRISTAVSKA"

HOE "PRISTAVSKA"
HOUE "PRISTAVSKA"



Art. No.	(A x B)			<i>i</i>
716 995	230 x 260	1,40	-	-
754 348	230 x 260	2,20	1200	-

MOTIKA RADGONSKA
HAUE "RADGONSKA"

HOE "RADGONSKA"
HOUE "RADGONSKA"



Art. No.	(A x B)			<i>i</i>
748 031	240 x 220	0,80	-	-
756 574	240 x 220	1,80	1300	-

MOTIKA IMOTSKA
HAUE "IMOTSKA"

HOE "IMOTSKA"
HOUE "IMOTSKA"



Art. No.	(A x B)			<i>i</i>
757 013	225 x 230	1,20	-	-



GRABLJE, STRGALA IN GREBLJICE, VRTNO IN CVETLIČNO ORODJE
RECHEN, HACKEN UND KRATZER, BLUMEN GERÄTE UND GARTEN GERÄTE
RAKES, POKER AND SCRAPER, FLOWER AND GARDEN TOOLS



GRABLJE VRTNE
GARTENRECHEN

GARDEN RAKE
RÂTEAU DE JARDIN



Art. No.		(AxBxC)			<i>i</i>
731 359	8Z	197 x 80 x 5	0,30	-	ø24
731 360	10Z	251 x 80 x 5	0,40	-	ø24
731 357	8Z	197 x 80 x 5	0,85	1500	ø24
731 358	10Z	251 x 80 x 5	0,95	1500	ø24

GRABLJE Z NASADILOM
RECHEN MIT STIFT

RAKE WITH TANG
RÂTEAU



Art. No.		(AxBxC)			<i>i</i>
759 207	8Z	197 x 85 x 5	0,28	-	N3
759 208	10Z	250 x 85 x 5	0,35	-	N3
759 391	12Z	305 x 85 x 5	0,42	-	N3
757 875	14Z	360 x 85 x 5	0,49	-	N3
757 876	16Z	413 x 85 x 5	0,56	-	N3

GRABLJE VRTNE
GARTENRECHEN

GARDEN RAKE
RÂTEAU DE JARDIN



Art. No.		(AxBxC)			<i>i</i>
731 361	12Z	305 x 80 x 5	0,50	-	ø28
731 362	14Z	360 x 80 x 5	0,60	-	ø28
731 363	16Z	413 x 80 x 5	0,70	-	ø28
731 354	12Z	305 x 80 x 5	1,25	1500	ø28
731 355	14Z	360 x 80 x 5	1,35	1500	ø28
731 356	16Z	413 x 80 x 5	1,45	1500	ø28

GRABLJE Z NASADILOM IN NOSILCEM
RECHEN MIT STIFT UND TREGER

RAKE WITH TANG
RÂTEAU



Art. No.		(AxBxC)			<i>i</i>
757 633	14Z	360 x 80 x 5	0,67	-	N6

GRABLJE VRTNE
GARTENRECHEN

GARDEN RAKE
RÂTEAU DE JARDIN



Art. No.		(AxBxC)			<i>i</i>
716 137	18Z	467 x 80 x 5	0,80	-	ø28
716 139	20Z	520 x 80 x 5	0,90	-	ø28
713 267	18Z	467 x 80 x 5	1,55	1500	ø28
731 268	20Z	520 x 80 x 5	1,65	1500	ø28

GRABLJE Z NASADILOM IN NOSILCEM
RECHEN MIT STIFT UND TREGER

RAKE WITH TANG
RÂTEAU



Art. No.		(AxBxC)			<i>i</i>
757 640	14Z	360 x 85 x 5	0,80	-	N3
757 872	16Z	413 x 85 x 5	0,81	-	N3

GRABLJE VRTNE
GARTENRECHEN

GARDEN RAKE
RÂTEAU DE JARDIN



Art. No.		(AxBxC)			<i>i</i>
711 760	30Z	590 x 62 x 3	0,55	-	ø24
779 254	30Z	590 x 62 x 3	1,10	1500	ø28

CESTARSKÉ LAHKE UPOGNJENE
STRASSENRECHEN DLEICHT GEBOGEN

ROAD RAKE LIGHT
RÂTEAU FORGÉ



Art. No.		(AxBxC)			<i>i</i>
762 150	12Z	305 x 77 x 5	0,42	-	D26
762 151	14Z	360 x 77 x 5	0,49	-	D26
762 152	16Z	413 x 77 x 5	0,56	-	D26

GRABLJE VRTNE Z NASADILOM
GARTENRECHEN MIT STIFT

GARDEN RAKE
RÂTEAU



Art. No.		(AxBxC)			<i>i</i>
759 206	8Z	197 x 77 x 5	0,28	-	N3
759 063	10Z	250 x 77 x 5	0,35	-	N3
759 064	12Z	305 x 77 x 5	0,42	-	N3
759 065	14Z	360 x 77 x 5	0,49	-	N3
759 066	16Z	413 x 77 x 5	0,56	-	N3
762 228	14Z	360 x 77 x 5	1,30	1700	N3

CESTARSKÉ LAHKE RAVNE
STRASSENRECHEN LEICHT GERADE

ROAD RAKE
RÂTEAU FORGÉ



Art. No.		(AxBxC)			<i>i</i>
762 153	12Z	305 x 77 x 5	0,42	-	D26
762 154	14Z	360 x 77 x 5	0,49	-	D26
762 155	16Z	413 x 77 x 5	0,56	-	D26

GRABLJE Z NASADILOM
RECHEN MIT STIFT

RAKE WITH TANG
RÂTEAU



Art. No.		(AxBxC)			<i>i</i>
757 688	10Z	205 x 85 x 5	0,37	-	N6
756 482	12Z	305 x 85 x 5	0,44	-	N6
756 483	14Z	360 x 85 x 5	0,51	-	N6
756 484	16Z	413 x 85 x 5	0,58	-	N6

GRABLJE CESTARSKÉ LAHKE
STRASSENBAURECHEN LEICHT

ROAD RAKE LIGHT
RÂTEAU FORGÉ



Art. No.		(AxBxC)			<i>i</i>
716 144	8Z	197 x 80 x 5	0,35	-	D26
716 145	10Z	251 x 80 x 5	0,45	-	D26
752 898	12Z	305 x 80 x 5	0,50	-	D26
752 899	14Z	306 x 80 x 5	0,55	-	D26
752 900	16Z	413 x 80 x 5	0,65	-	D26
764 085	14Z	360 x 80 x 5	1,00	1500	-

GRABLJE CESTARSKÉ - TEŽKÉ
STRABENRECHEN SCHWER

ROAD RAKE HEAVY
RÂTEAU FORGÉ À CAILLOUTIS



Art. No.	(AxBxC)				<i>i</i>
753 114	10Z 305 x 120 x 5	0,85	-	ø35	-
739 969	12Z 390 x 120 x 5	1,00	-	ø35	-
752 430	14Z 456 x 120 x 5	1,11	-	ø35	-
752 901	16Z 524 x 120 x 5	1,27	-	ø35	-
764 088	14Z 456 x 120 x 5	2,00	1500	-	-

GRABLJE REZILNE
RASENLÜFTER

LAWN RAKE
SCARIFICATEUR



Art. No.	(AxBxC)				<i>i</i>
756 480	14Z 382 x 100 x 3	0,81	-	-	-
756 894	14Z 382 x 100 x 3	1,46	1500	-	-

GRABLJE Z NOSILCEM ENOJNIM
MISCHGUTRECHEN

RAKE WITH HOLDER
RÂTEAU



Art. No.	(AxBxC)				<i>i</i>
753 779	14Z 386 x 115 x 5	1,00	-	-	-
753 298	16Z 444 x 115 x 5	1,00	-	-	-

GRABLJE CVETLIČNE
BLUMENRECHEN

FLOWER RAKE
RÂTEAU



Art. No.	(AxBxC)				<i>i</i>
759 606	10Z 243 x 70 x 3	0,25	-	-	-

GRABLJE Z NOSILCEM DVOJNIM
MISCHGUTRECHEN

ASPHALT RAKE
RÂTEAU



Art. No.	(AxBxC)				<i>i</i>
753 299	16Z 444 x 115 x 5	1,20	-	-	-

GREBLJICA ZA MALTO
KOTKRÜCKE

MORTAR SCRAPER
RACLOIR



Art. No.	(AxB)				<i>i</i>
716 102	270 x 130	0,80	-	-	-
744 189	270 x 130	1,80	1300	-	-

GRABLJE CESTARSKÉ Z JARMOM
TEERRECHEN

TARMAC RAKE
RÂTEAU FORGÉ



Art. No.	(AxBxC)				<i>i</i>
756 470	14Z 372 x 82 x 25	1,55	-	-	-
756 473	14Z 372 x 82 x 25	2,65	1320	-	-
756 472	14Z 372 x 82 x 25	2,60	1330	-	-

GREBLJICA CESTARSKA
KOTKRÜCKE

ROAD SCRAPER
RACLOIR



Art. No.	(AxB)				<i>i</i>
724 788	300 x 100	0,90	-	-	-
724 787	345 x 100	1,00	-	-	-
762 962	300 x 100	1,80	1300	-	-

GRABLJE ZA ASFALT
TEERRECHEN

ASPHALT RAKE
RÂTEAU FORGÉ



Art. No.	(AxBxC)				<i>i</i>
756 476	16Z 440 x 90 x 6	1,30	-	-	-
756 479	16Z 440 x 90 x 6	1,45	1320	-	-
756 478	16Z 440 x 90 x 6	2,40	1330	-	-

GREBLJICA OKROGLA
SCHUFFEL

SCRAPER
RASETTE



Art. No.	(AxB)				<i>i</i>
759 500	140 x 45	0,42	-	-	-
759 501	160 x 45	0,43	-	-	-
759 502	180 x 45	0,44	-	-	-
759 503	200 x 45	0,45	-	-	-

GRABLJE CESTARSKÉ ZA ASFALT
TEERRECHEN

ASPHALT RAKE
RÂTEAU



Art. No.	(AxBxC)				<i>i</i>
752 902	16Z 413 x 85 x 5	1,70	-	-	-

GREBLJICA ORMOŠKA
UNKRAUTHACKE "ORMOŠKA"

SCRAPER "ORMOŠKA"
RASETTE "ORMOŠKA"



Art. No.	(AxB)				<i>i</i>
776 060	180 x 70	0,35	-	-	-
716 158	180 x 70	0,80	1400	-	-

GREBLJICA FRANCOSKA
UNKRAUTHACKE "FRANCOSKA"

SCRAPER "FRANCOSKA"
BINETTE "FRANCOSKA"



Art. No.	(A x B)			<i>i</i>
721 566	160 x 100	0,40	-	-
741 190	160 x 100	0,75	1100	-

ČRTALO ZA VRSTE
RILLENZIEHER

PULLER LINE ADJUSTABLE
SILLONNEUR RÉGLABLES



Art. No.	(A x B)			<i>i</i>
716 247	670 x 160	1,40	-	-
776 178	670 x 160	2,35	150	-

STRGALO ZA CENTRALNO PEČ
CENTRALHEIZUNG KRATZER

CENTRAL HEATING SCRAPER
GRATTOIR



Art. No.	(A x B)			<i>i</i>
716 162	150 x 58	750	-	-

STRGALO SRČASTO
SCHUFFEL

SCUFFLE HOE
RASETTE HOLLANDAISE



Art. No.	(A x B)			<i>i</i>
759 408	160 x 83	0,40	-	-
759 409	200 x 83	0,45	-	-

STRGALO TOGO
BÜGELJÄTER

PULL HOE
RASETTE Á TIRER



Art. No.	(A x B)			<i>i</i>
716 280	160 x 40	0,40	-	-
776 166	160 x 40	0,80	1400	-

MOTIČICA CVETLIČNA
KLEINHACKE

FLOWER HOE
SERFOUETTE



Art. No.	(A x B)			<i>i</i>
721 182	190 x 60	0,13	-	-
716 254	190 x 60	0,20	300	-

STRGALO TOGO "F"
BÜGELJÄTER F

WEED CUTER F
GRATTOIR DE JARDIN



Art. No.	(A x B)			<i>i</i>
774 811	160 x 30	0,30	-	-
776 167	160 x 30	0,75	1400	-

GRABEŽ PLEVELA
GRUBBER

WEED RAKE
GRIFFE



Art. No.	(A x B)			<i>i</i>
739 373	85 x 70	0,06	-	-
716 243	85 x 70	0,11	160	-

STRGALO POMIČNO
PENDELJÄTER

MOVE SCRAPER
SUBRA CLETTE



Art. No.	(A x B)			<i>i</i>
716 281	125 x 30	0,50	-	-
776 176	125 x 30	1,25	1500	-

KLIN SADILNI
STAHLPLANCER

DIBBER
PLANTOIR



Art. No.	(A x B)			<i>i</i>
716 242	200 x 40	0,20	K100	-
763 838	240 x 40	0,30	-	-

STRGALO ZA BLATO
SCHUFFEL

SCUFFLE HOE
RASETTE



Art. No.	(A x B)			<i>i</i>
758 563	140 x 56	0,38	-	-
758 564	160 x 56	0,40	-	-
758 565	180 x 56	0,45	-	-
758 566	200 x 56	0,50	-	-

MOTIČICA CVETLIČNA RAVNA
KLEINHACKE

FLOWER HOE - FLAT
SERFOUETTE



Art. No.	(A x B)			<i>i</i>
739 369	200 x 40	0,13	-	-
716 253	200 x 40	0,20	300	-

RAHLJAČ CVETLIČNI GRUBBER **FLOWER TORMENTOR GRIFFE**

Art. No.	(A x B)			<i>i</i>
739 371	100 x 70	0,10	-	-
716 244	100 x 70	0,17	300	-

METLA ŽIČNA 35 LAUBRECHEN 35 DRAHT **LAWN RAKE 35 WIRE BALAI**

Art. No.	(A x B)			<i>i</i>
764000	350 x 400	0,45	-	-
763980	350 x 400	0,90	1300	-

LOPATICA CVETLIČNA BLUMENKELLE **TROWEL TRANPLANTOIR**

Art. No.	(A x B)			<i>i</i>
763 839	280 x 125	0,25	-	-
716 241	280 x 125	0,20	100	-

METLA ŽIČNA 50 LAUBRECHEN 50 DRAHT **LAWN RAKE 50 WIRE BALAI**

Art. No.	(A x B)			<i>i</i>
764003	500 x 500	0,65	-	-
763981	500 x 500	1,10	1300	-

METLIČA ŽIČNA DRATHHANDFEGER **WIRED BROOM RÂTEAU**

Art. No.	(A x B)			<i>i</i>
716 263	280 x 125	0,25	100	-

METLA PERESNA FIKSNA LAUBRECHEN FEST **LAWN RAKE FIXED BALAI**

Art. No.	(A x B)			<i>i</i>
764008	450 x 450	0,60	-	-
763982	450 x 450	1,05	1300	-

GRABLJICE CVETLIČNE 6Z KLEINRECHEN **FLOWER RAKE RÂTEAU**

Art. No.	(A x B)			<i>i</i>
738 945	108 x 43	0,13	-	-
772 247	108 x 43	0,20	300	-

METLA PERESNA NASTAVLJIVA LAUBRECHEN VERSTELLBAR **LAWN RAKE ADJUSTABLE BALAI**

Art. No.	(A x B)			<i>i</i>
764005	450 x 450	0,65	-	-
763982	450 x 450	1,10	1300	-

SADILEC ČEBULIC BLUMENZWIEBEL PFLANZER **BULB PLANER PLANTOIR Á BULBES**

Art. No.	(A x B)			<i>i</i>
775 512	240 x 180	0,25	-	-

ČISTILEC ČEVLJEV SCHUHPUTZER **SHOE CLINER SERFOUETTE**

Art. No.	(A x B)			<i>i</i>
758 582	180 x 180	2,54	850	-

GREBLJICA CVETLIČNA BLUMENHACKE **GARDEN PULL HOE RASETTE**

Art. No.	(A x B)			<i>i</i>
738 944	100 x 60	0,13	-	-
774 764	100 x 60	0,20	300	-

KOMPLETI SATZ **SUIT TROUSSE**

777 727	716241+716243+772247			KPL.5
776 340	716241+716242+716253+772247			KPL.6
776 341	716241+716242+716243+772247			KPL.8
726 580	724772+724769+724754+724756+724758+724764			KPL. Otroški program

LOPATICA KONIČASTA METAČA
KINDER SPITZSCHAUFEL

THROWING SHOVEL - TIPPED
PELLE



Art. No.	(AxB)			<i>i</i>
724 753	145 x 144	0,18	-	-
724 754	145 x 144	0,40	760	-

MOTIČICA RAVNA F 3R
KINDER GARTENHACKE

HOE FLAT
SERFOUETTE



Art. No.	(AxB)			<i>i</i>
724 771	178 x 60	0,20	-	-
724 772	178 x 60	0,42	760	-

LOPATICA RAVNA METAČA
KINDERSCHAUFEL

THROWING SHOVEL - FLAT
PELLE



Art. No.	(AxB)			<i>i</i>
724 755	132 x 117	0,19	-	-
724 756	132 x 117	0,41	760	-

MOTIČICA VRTNA KONIČASTA
GARTENHACKE, MIT HERZBLATT

SMALL GARDEN HOE
SERFOUETTE



Art. No.	(AxB)			<i>i</i>
750 555	230 x 280	0,25	-	ø24
755 016	230 x 280	0,45	750	ø24
755 045	230 x 280	0,50	1100	ø24
755 017	230 x 280	0,55	1400	ø24
749 357	240 x 280	0,25	-	ø21
776 066	240 x 280	0,45	750	ø21
776 067	240 x 280	0,50	1100	ø21
776 080	240 x 280	0,55	1400	ø21

LOPATICA RAVNA PREKOPNA
KINDERSPATEN

DIGGING SHOVEL
BÉCHE



Art. No.	(AxB)			<i>i</i>
724 757	145 x 107	0,16	-	-
724 758	145 x 107	0,38	760	-

MOTIČICA VRTNA RAVNA
GARTENHACKE, MIT RECHTECKBLATT

SMALL GARDEN HOE
SERFOUETTE



Art. No.	(AxB)			<i>i</i>
772 242	220 x 65	0,25	-	ø24
775 018	220 x 65	0,45	750	ø24
775 046	220 x 65	0,50	1100	ø24
775 019	220 x 65	0,55	1400	ø24
772 243	230 x 65	0,25	-	ø21
776 069	230 x 65	0,50	1100	ø21

RAHLJAČ
KINDER GRUBBER

TORMENTOR
GRIFFE



Art. No.	(AxB)			<i>i</i>
724 768	75 x 70	0,14	-	-
724 769	75 x 70	0,36	760	-

MOTIČICA VRTNA
GARTENHACKE, MIT RECHTECKBLATT

SMALL GARDEN HOE
SERFOUETTE



Art. No.	(AxB)			<i>i</i>
773 604	265 x 80	0,305	-	ø21
776 073	265 x 80	0,55	1100	ø21

GRABLJICE F 8Z
KINDER RECHEN

RAKE
RÂTEU



Art. No.	(AxB)			<i>i</i>
724 763	148 x 62	0,16	-	-
724 764	148 x 62	0,38	760	-

KULTIVATOR 3 KOV.
KULTIVATOR

CULTIVATOR
CULTIVATEUR



Art. No.	(AxB)			<i>i</i>
716 248	140 x 105	0,35	-	-
776 177	140 x 105	0,80	140	-



ZIMSKI PROGRAM
WINTER PROGRAMM
WINTER PROGRAMME



LOPATA SNEŽNA 400 S TULJAVO
SCHNEESCHAUFEL 400 MIT DÜLLE

SNOW SHOVEL
POUSSOIR À NEIGE



Art. No.	(AxB)				<i>i</i>
748 990	400 x 350 AL	1,20	-	-	-
776 165	400 x 350 AL	1,90	1300	-	-

LOPATA SNEŽNA 500 S TULJAVO
SCHNEESCHIEBER MIT DÜLLE

SNOW SHOVEL
POUSSOIR À NEIGE



Art. No.	(AxB)				<i>i</i>
758 545	500 x 350 AL	1,40	-	-	-
716 245	500 x 350 AL	2,10	1250	-	-

LOPATA SNEŽNA 400 Z VIJAKI
SCHNEESCHAUFEL 400 MIT SCHRAUBEN

SNOW SHOVEL
POUSSOIR À NEIGE



Art. No.	(AxB)				<i>i</i>
758 547	400 x 350 AL	1,00	-	-	-
758 468	400 x 350 AL	1,70	1300	-	-

LOPATA SNEŽNA 500 Z VIJAKI
SCHNEESCHIEBER MIT SCHRAUBEN

SNOW SHOVEL
POUSSOIR À NEIGE



Art. No.	(AxB)				<i>i</i>
758 549	500 x 350 AL	1,20	-	-	-
758 466	500 x 350 AL	1,90	1250	-	-

LOPATA SNEŽNA 400 S SPONKO
SCHNEESCHAUFEL 400 MIT KLEMMFIX

SNOW SHOVEL
POUSSOIR À NEIGE



Art. No.	(AxB)				<i>i</i>
758 551	400 x 350 AL	1,00	-	-	-
758 469	400 x 350 AL	1,70	1250	-	-

LOPATA SNEŽNA 500 S SPONKO
SCHNEESCHIEBER MIT KLEMMFIX

SNOW SHOVEL
POUSSOIR À NEIGE



Art. No.	(AxB)				<i>i</i>
758 553	500 x 350 AL	1,20	-	-	-
758 467	500 x 350 AL	1,90	1250	-	-

LOPATA ALU-9
ALU SCHAUFEL NR.9

ALUMINIUM SHOVEL NR.9
PELLE ALUMINIUM



Art. No.	(AxB)				<i>i</i>
779 196	390 x 360 AL	1,05	-	-	-
779 481	390 x 360 AL	2,00	1300	-	-

LOPATA SNEŽNA 60
SCHNEESCHIEBER

SNOW SHOVEL
POUSSOIR À NEIGE



Art. No.	(AxB)				<i>i</i>
758 933	465 x 335 AL	0,60	-	-	-
759 049	465 x 335 AL	1,20	1500	-	-

LOPATA ALU-7
ALU SCHAUFEL NR.7

ALUMINIUM SHOVEL NR.7
PELLE ALUMINIUM



Art. No.	(AxB)				<i>i</i>
759 971	325 x 340 AL	0,95	-	-	-
762 347	325 x 340 AL	1,80	1300	-	-

LOPATA SNEŽNA PONVASTA
SCHNEESCHAUFEL

SNOW SHOVEL
PELLES À NEIGE



Art. No.	(AxB)				<i>i</i>
763417	310 x 450	0,90	-	-	-
763422	310 x 450	1,85	1300	-	-

LOPATA EFEKT
SCHAUFEL EFEKT

SHOVEL EFEKT
PELLES EFEKT



Art. No.	(A x B)			<i>i</i>
763936	370 x 460	1,60	1250	-

LOPATA ZLOŽLJIVA
KLAPPSPATEN

ARMY FOLDING SHOVEL
PELLE PLIABLE



Art. No.	(A x B)			<i>i</i>
752696	605 x 155	1,23	-	-

STRGALO ZA LED
STOßSCHARRE

ICE SCRAPER
GRATOIR



Art. No.	(A x B)			<i>i</i>
716 104	140 x 100	0,60	-	-
721 930	140 x 100	1,15	1100	-

STRGALO 200
STOßSCHARRE 200

FLOOR SCRAPER 200
GRATOIR 200



Art. No.	(A x B)			<i>i</i>
759 693	203 x 76	0,45	-	-
756 335	203 x 76	1,50	1320	-

STRGALO 140 & 300
EISSTÖßER

ICE SCRAPER
GRATOIR



Art. No.	(A x B)			<i>i</i>
757 092	140 x 120	0,60	-	-
758 952	300 x 120	1,25	-	-
759 764	140 x 120	1,55	1300	-
759 765	300 x 120	2,20	1300	-

STRGALO 150, 300 & 500
STOßSCHARRE

SCRAPER
GRATOIR



Art. No.	(A x B)			<i>i</i>
743 105	150 x 150	0,55	-	NO
759 760	150 x 150	0,55	-	NO
743 106	300 x 150	0,90	-	NO
759 761	300 x 150	0,90	-	NO
758 184	300 x 150	1,00	-	OJ
764 027	300 x 150	1,00	-	OJ
743 107	500 x 150	1,60	-	OJ
759 762	500 x 150	1,60	-	OJ
758 939	150 x 150	1,15	1300	NO
758 940	300 x 150	1,50	1300	NO
758 941	300 x 150	1,60	1300	OJ
758 942	500 x 150	2,00	1300	OJ

NABIJAČ
STAMPFER

POST RAMMER
DAME RONDE



Art. No.	(A x B)			
757 936	ø140 x 660	14,8	-	-
757 937	ø165 x 660	18,0	-	-

NABIJALEC BETONA
BETONSTAMPFER

CONCRETE HAMMER
DAME DE CARRECEUR



Art. No.	(A x B x C)				<i>i</i>
759 575	150 x 150 x 810	8,25	-	-	-
758 966	200 x 200 x 810	12,15	1300	-	-

OKOVJE
SCHIENENZWINGE, BÜCHSE

FERRULE
FERULE ET CAPUCHON



Art. No.					<i>i</i>
757332	L = 230	0,11	-	ø23,8	-
763016	L = 85	0,05	-	ø23,8	-

Profesionalno orodje Made in Slovenia

Tradicija kovaštva od leta 1573
Visokokvalitetni kovani in kaljeni proizvodi
Visokokvalitetni jesenovi lakirani ročaji
5 let garancije

Profiwerkzeuge Made in Slovenia

Schmiedetradition seit 1573
Hochwertige Schmiedeprodukte
Hochwertige Stiele aus lackiertem Eschenholz
5 Jahre Garantie

Professional tools Made in Slovenia

Tradition since 1573
High-quality forged and hardened products
High-quality lacquered ash handles
5 years guarantee



ODKOVKI IN PLOČEVINASTI DELI
SCHMIEDE- UND BLECHTEILE
FORGINGS AND SHEET METAL PRODUCTS



Podjetje izvaja tudi sledeče storitve:

- utopno kovanje – odkovki teže med 0,5 kg in 6 kg
ter dolžine do 350 mm
- izsekovanje
- upogibanje
- globoki vlek
- žarjenje
- kaljenje
- popuščanje
- cementiranje
- peskanje
- izdelava orodij

In unserem Schmiedebetrieb haben wir folgende Bearbeitungsmöglichkeiten:

- Gesenkschmieden und Freiformschmieden –
Schmiedeteile von 0,5 kg bis 6 kg und Abmessungen
bis cca. 350 mm
- Stanzen
- Biegen
- Tiefziehen
- Glühen
- Härten
- Anlassen
- Zementieren
- Sandstrahlen
- Werkzeugbau

In our company the following services are performed:

- sink forging – forgings from 0,5 kg – 6 kg and
dimension up to 350 mm
- stamping
- bending
- deep traction
- incandescing
- hardening
- tempering
- cementation
- sandblasting
- tool construction and production

STRUC Kovačija Muta

www.struc.info

Na spletni strani www.struc.info si lahko ogledate širok program naših izdelkov.

Auf www.struc.info finden Sie umfangreiche Informationen über unsere Produkte.

Have a look at www.struc.info to see our wide range of products.

STRUC Holding



- STRUC Kovačija Muta d.o.o.
- STRUC MUTA, kmetijska mehanizacija d.o.o.
- STRUC Ekoing d.o.o.
- STRUC Tovarna Kos in srpov d.o.o.
- STRUC Bukev d.o.o.
- STRUC Tokos d.o.o.

STRUC  since 1573
Kovačija Muta
a company of STRUC Holding

STRUC Kovačija Muta d.o.o.
Tel. h.c.: +386 (0)2 8723-903
Fax: +386 (0)2 8723-904
E-Mail: kovacija@struc.info
www.struc.info

