



STRUC



since 1881

TOVARNA KOS
IN SRPOV

a company of STRUC Holding

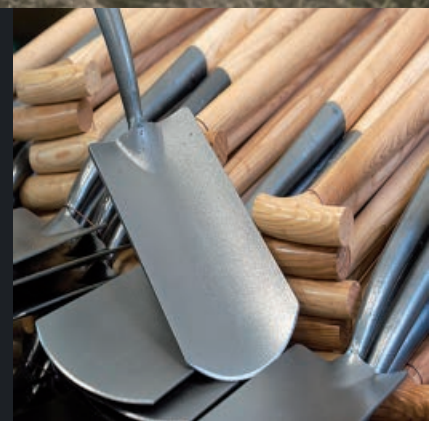

MADE IN SLOVENIA

STRUC Tovarna kos in srpov d.o.o.
Lovrenc na Pohorju
since 1881

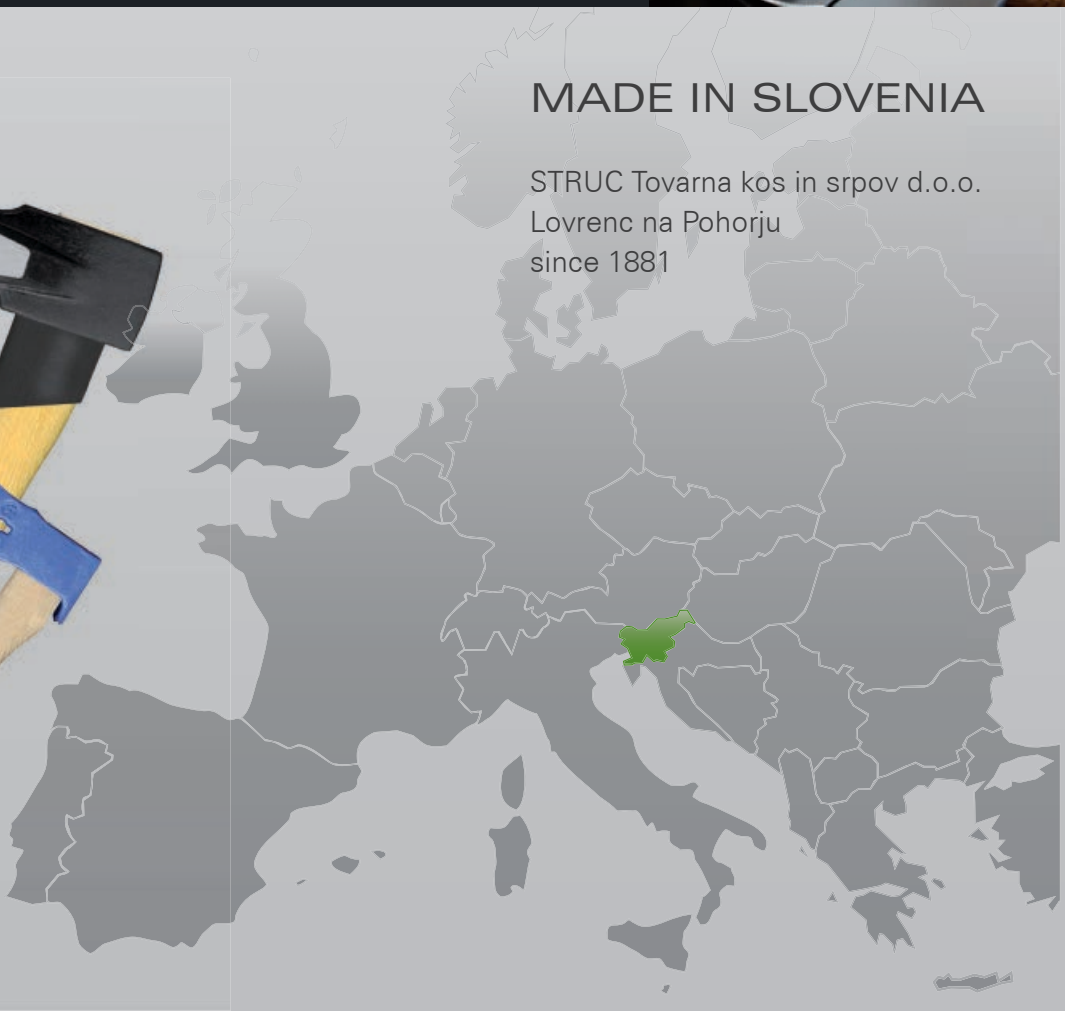



HANDWERK MIT TRADITION
CRAFT MEETS TRADITION
OBRT S TRADICIJO

QUALITÄT GEWACHSEN AUS TRADITION
HOCHWERTIGE MATERIALIEN IM EINSATZ
QUALITÄTSBEWUSSTSEIN, DAS VERTRAUEN
SCHENKT.

STRUC Tovarna kos in srpov d.o.o. ist eine Firma
der STRUC Holding GmbH.

Die STRUC Holding ist eine familiengeführte, mittelständische Unternehmensgruppe, die in mehreren Branchen in Slowenien und Deutschland tätig ist. Unser Hauptsegment liegt in der Herstellung von landwirtschaftlichen Werkzeugen, Bau- und Gartengeräten sowie industriellen Schmiedeteilen und Blecherzeugnissen. Darüber hinaus sind wir mit zwei Standorten in Deutschland auch in dem Bereich Sondermaschinenbau sowie in der Kunststofffensterfabrikation vertreten. Die Vielfalt ist unsere Stärke!

QUALITZ DEVELOPPED FROM TRADITION
MATERIALS OF HIGH QUALITZ IN USE
A QUALITZ CONSCIOUSNESS WHICH PROVIDES
CONFIDENCE

STRUC Tovarna kos in srpov d.o.o. is a company of
the STRUC Holding GmbH.

The STRUC holding is a family-run, medium-sized group of companies which operates in various sectors in Slovenia and Germany. In Slovenia, we produce mainly agricultural-, contractors- and gardening tools as well as industrial forgings and sheet metals. Furthermore, we have got two more locations in Germany where we produce special purpose machines, production lines and PVC windows. We offer a huge range of products which makes our companies so succesful.

KVALITETA ZRASTLA IZ TRADICIJE
UPORABA KAKOVOSTNIH MATERIALOV
ZAVEZA H KVALITETI, KI VZBUJA ZAUPANJE

STRUC Tovarna kos in srpov d.o.o. je del
STRUC Holding GmbH

STRUC Holding je srednje velika, družinsko vodena skupina podjetij, ki deluje na večih področjih v Sloveniji in Nemčiji. Naše glavno področje je proizvodnja kmetijskega, gradbenega in vrtnega orodja, kot tudi industrijskih odkovkov in izdelkov iz pločevine. Poleg tega smo v Nemčiji prisotni na dveh lokacijah, s proizvodnjo specialnih strojev, kot tudi s proizvodnjo oken iz umetne mase. Naša moč je v raznolikosti.



STRUC Holding



- STRUC Tovarna kos in srpov d.o.o.
 - STRUC Kovačija Muta d.o.o.
 - STRUC MUTA, kmetijska mehanizacija d.o.o.
 - Bukev d.o.o.
 - STRUC Tokos d.o.o.
 - STRUC Ekoing d.o.o.
 - Ketterer Technologies GmbH
 - STRUC Kunststoffesnterfabrikations GmbH
- www.struc-holding.com



Wir garantieren Ihnen beste Qualität und saubere Verarbeitung unserer Produkte

Best quality and accurate processing of our products are taken for granted.

Zagotavljamo Vam najboljšo kakovost in strokovno izdelavo naših izdelkov



STRUC
BUKEV



Unsere Vor-Ort ansässige Schwesterfirma Bukev d.o.o. ist auf die Holzbearbeitung und -verarbeitung spezialisiert. Unter anderem erfolgt hier die Produktion von Holzstielen

aller Art für die Werkzeuge der Firma Kos. Dies ermöglicht uns ein rundum komplettes Produkt- und Serviceprogramm anzubieten, bei dem alles aus einer Hand entwickelt, hergestellt und geliefert wird.

Our on-site subsidiary company Bukev d.o.o. is specialized in woodwork. Amongst other things, the production of wooden handles for all types of tools for our company, is carried out here. This enables us to offer an all-round production and service programme, in which the entire process of development, manufacturing and delivery are dealt with by one company. In doing so, we have got the possibility to have an influence on all production processes. Therefore we can assure highest quality.

Naše hčerinsko podjetje BUKEV d.o.o. je specializirano za obdelavo lesa. Med drugim izdeluje lesene ročaje za naša orodja. To nam omogoča celovito ponudbo proizvodnega in storitvenega programa, kjer so vsi izdelki razviti, izdelani in dobavljeni na enem mestu. Na ta način imamo neposreden vpliv na celotne proizvodne procese in tako lahko zagotovimo najvišjo kakovost.

TOVARNA KOS IN SRPOV

Die Firma Tovarna Kos in Srpov wurde 1881 von Herrn Heendrich Kieffer gegründet. Er war damit einer der Pioniere in der industriellen Fertigung von Sensen und Sichel innerhalb Europas. Heute zählen wir zu den großen Produzenten von Schmiedeteilen und Blecherzeugnissen in Europa.

Eine 130-jährige Erfahrung und Tradition in diesem Handwerk bilden die Basis für unsere Arbeit, welche sich in der Qualität und Haltbarkeit der Produkte niederschlägt. Unsere Hauptabsatzmärkte sind Slowenien, Ex-Jugoslawien sowie nahezu alle EU-Staaten. Insgesamt 70% unserer Produktion wird direkt in das Ausland geliefert.

Um den hohen Qualitätsanforderungen gerecht zu werden, wurden in den letzten Jahren kontinuierliche Investitionen und Modernisierungen durchgeführt.

TOVARNA KOS IN SRPOV

Gospod Heinrich Kieffer jo je ustanovil leta 1881. Bil je eden od pionirjev industrijske izdelave kos in srpov v Evropi. Danes šteujemo med velike proizvajalce kovanih in pločevinastih izdelkov.

130-letne izkušnje in tradicija v tej obrti tvorijo osnovo našega dela, ki se odraža v kakovosti in trajnosti proizvodov.

Naši glavni trgi so Slovenija in nekdanja Jugoslavija kot tudi skoraj vse evropske države. 70% naše proizvodnje se proda neposredno v tujino. Zaradi zahtev po visoki kakovosti smo v zadnjih letih veliko investirali in posodabljali.

TOVARNA KOS IN SRPOV

The company of Tovarna Kos in Srpov was founded in 1881 by Mr Heinrich Kieffer. In doing so, he became a pioneer of the industrial production of scythes and sickles within Europe. We are now one of the leading manufacturers of sheet metal and one of the largest smiths in Europe.

130 years of experience and tradition in this craft account for the quality and durability of our products. Our prime markets are Slovenia, former Yugoslavia and almost all EU countries. In total, 70% of our products are exported immediately.

A program of continual investment and modernization has been accomplished throughout the last years in order to meet the growing demands and expectations of our customers.



VON UNS AUF LANGLEBIGKEIT
UND ROBUSTHEIT GEPRÜFT

LONGEVITY AND
ROBUSTNESS ARE CERTIFIED

PREVERILI SMO TRAJNOST IN
VZDRŽLJIVOST NAŠIH IZDELKOV



BAUWERKZEUGE, WIE
ZUM BEISPIEL

Spaten, Schaufeln,
Kreuzhacken

BUILDING TOOLS,
AS FOR EXAMPLE

Spades, Shovels, Pick-axes



GRADBENO ORODJE, KOT NA PRIMER

lopate prekopne, lopate metače, krampi



EINE AXT VON STRUC TOVARNA KOS
IN SRPOV HÄLT DURCH!

AN AXE OF STRUC TOVARNA KOS
IN SRPOV STAYS THE COURSE!

SEKIRA STRUC TOVARNE KOS
IN SRPOV JE TRAJNA!

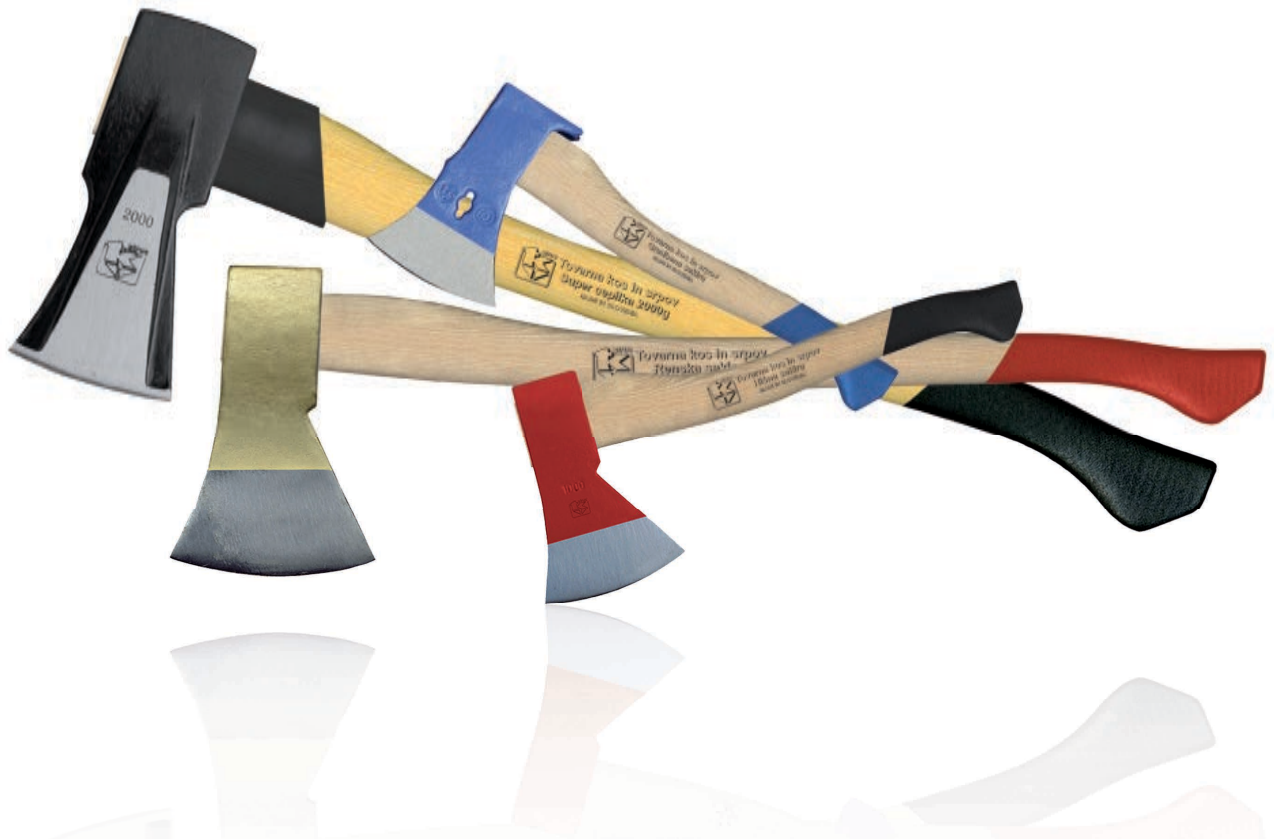

ÄXTE

umfangreiches Sortiment
an Äxten für den Forst- und
Baubereich

AXES

wide selection of axes for the building and
forest sector

SEKIRE

velika izbira sekir za gozdarstvo
in gradbeništvo



GUTE ARBEIT
BRAUCHT GUTES WERKZEUG

GOOD TOOLS FOR GOOD WORK

ZAHTEVNO DELO POTREBUJE
KAKOVOSTNO ORODJE

SEIT 1881

Erfahrung in der industriellen Herstellung von landwirtschaftlichen Werkzeugen, wie Sensen und Sichel

SINCE 1881

experience in the industrial production of agricultural tools, as for example Scythes and Sickles

OD LETA 1881

od leta 1881 izkušnje v industrijski izdelavi poljedelskega orodja, kot so kose in srpi



HANDWERK MIT TRADITION
CRAFT MEETS TRADITION
OBRT S TRADICIJO



STRUC TOVARNA KOS IN SRPOV d.o.o.
A COMPANY OF STRUC HOLDING



www.struc-holding.com

KOSA OZKA 45 NARROW SCYTHE 45
SCHMALE SENSE 45 FAUX 45

GESCHMIEDET	Art. No.	(a x b)			mm		
	61190000	45x450	0,29	-	50		
	61190100	45x500	0,32	-	50		
	61190200	45x550	0,35	-	50		
	61190300	45x600	0,37	-	50		
	61190400	45x650	0,40	-	50		
	61190500	45x700	0,45	-	50		
	61190600	45x750	0,48	-	50		
	61190700	45x800	0,52	-	50		
	61190800	45x850	0,55	-	50		
	61190900	45x900	0,60	-	50		

KOSA ŠTAJERSKA BREZ BRADE 64 SCYTHE STYRIA WITHOUT B. 64
STEIRISCHE SENSE OHNE BART 64 FAUX 64

GESCHMIEDET	Art. No.	(a x b)			mm		
	61015100	64x500	0,48	-	50		
	61015200	64x550	0,52	-	50		
	61015300	64x600	0,56	-	50		
	61015400	64x650	0,60	-	50		
	61015500	64x700	0,68	-	50		
	61015600	64x750	0,71	-	50		

KOSA ŠTAJERSKA 55 SCYTHE STYRIA 55
STEIRISCHE SENSE 55 FAUX 55

GESCHMIEDET	Art. No.	(a x b)			mm		
	61010200	55x500	0,40	-	50		
	61011000	55x550	0,44	-	50		
	61011100	55x600	0,47	-	50		
	61011200	55x650	0,50	-	50		
	61011300	55x700	0,53	-	50		
	61011400	55x750	0,55	-	50		
	61011500	55x800	0,58	-	50		
	61011600	55x850	0,61	-	50		
	61011700	55x900	0,65	-	50		

KOSA ŠTAJERSKA BREZ BRADE 70 SCYTHE STYRIA WITHOUT B. 70
STEIRISCHE SENSE OHNE BART 70 FAUX 70

GESCHMIEDET	Art. No.	(a x b)			mm		
	61019100	70x650	0,71	-	50		

KOSA ŠTAJERSKA 50 SCYTHE STYRIA 50
STEIRISCHE SENSE 50 FAUX 50

GESCHMIEDET	Art. No.	(a x b)			mm		
	61013100	50x600	0,48	-	50		
	61013200	50x650	0,51	-	50		
	61013300	50x700	0,54	-	50		
	61013400	50x750	0,57	-	50		
	61013500	50x800	0,60	-	50		

KOSA ŠTAJERSKA Z BRADO 54 SCYTHE STYRIA WITH BEARD 54
STEIRISCHE BARTSENSE 54 FAUX 54

GESCHMIEDET	Art. No.	(a x b)			mm		
	61016100	54x500	0,51	-	50		
	61016200	54x550	0,54	-	50		
	61016300	54x600	0,57	-	50		
	61016400	54x650	0,60	-	50		
	61016500	54x700	0,64	-	50		
	61016600	54x750	0,67	-	50		

KOSA ŠTAJERSKA 55 - BELGIJA SCYTHE STYRIA 55 - BELGIUM
STEIRISCHE SENSE 55 - BELGIEN FAUX 55

GESCHMIEDET	Art. No.	(a x b)			mm		
	61372000	55x450	0,37	-	50		
	61372100	55x500	0,41	-	50		
	61372300	55x600	0,50	-	50		
	61372500	55x700	0,57	-	50		

KOSA ŠTAJERSKA Z BRADO 64 SCYTHE STYRIA WITH BEARD 64
STEIRISCHE BARTSENSE 64 FAUX 64

GESCHMIEDET	Art. No.	(a x b)			mm		
	61017100	64x500	0,57	-	50		
	61017200	64x550	0,61	-	50		
	61017300	64x600	0,65	-	50		
	61017400	64x650	0,69	-	50		
	61017500	64x700	0,73	-	50		
	61017600	64x750	0,78	-	50		

KOSA ŠTAJERSKA BREZ BRADE 54 SCYTHE STYRIA WITHOUT B. 54
STEIRISCHE SENSE OHNE BART 54 FAUX 54

GESCHMIEDET	Art. No.	(a x b)			mm		
	61014100	54x500	0,38	-	50		
	61014200	54x550	0,41	-	50		
	61014300	54x600	0,44	-	50		
	61014400	54x650	0,47	-	50		
	61014500	54x700	0,50	-	50		
	61014600	54x750	0,55	-	50		

KOSA ŠTAJERSKA Z BRADO 70 SCYTHE STYRIA WITH BEARD 70
STEIRISCHE BARTSENSE 70 FAUX 70

GESCHMIEDET	Art. No.	(a x b)			mm		
	61018100	70x500	0,61	-	50		
	61018200	70x550	0,65	-	50		
	61018300	70x600	0,69	-	50		
	61018400	70x650	0,73	-	50		
	61018500	70x700	0,77	-	50		
	61018600	70x750	0,81	-	50		

KOSA KRANJSKA 60 SCYTHE CARNIOLA 60
KRAINER SENSE 60 FAUX 60

GESCHMIEDET	Art. No.	(a x b)			mm	
	61020900	60x500	0,48	-	50	
	61021000	60x550	0,50	-	50	
	61021100	60x600	0,52	-	50	
	61021200	60x650	0,54	-	50	
	61021300	60x700	0,58	-	50	
	61021400	60x750	0,62	-	50	
	61021500	60x800	0,66	-	50	

KOVANO

KOSA KRANJSKA Z BRADO 64 SCYTHE CARNIOLA WITH BEARD 64
KRAINER BARTSENSE 64 FAUX 64

GESCHMIEDET	Art. No.	(a x b)			mm	
	61023100	64x500	0,51	-	50	
	61023200	64x550	0,54	-	50	
	61023300	64x600	0,57	-	50	
	61023400	64x650	0,60	-	50	
	61023500	64x700	0,61	-	50	
	61023600	64x750	0,65	-	50	

KOVANO

KOSA KRANJSKA BREZ BRADE 54 SCYTHE CARNIOLA WITHOUT B. 54
KRAINER SENSE OHNE BART 54 FAUX 54

GESCHMIEDET	Art. No.	(a x b)			mm	
	61022000	54x450	0,41	-	50	
	61022100	54x500	0,46	-	50	
	61022200	54x550	0,50	-	50	
	61022300	54x600	0,53	-	50	
	61022400	54x650	0,56	-	50	
	61022500	54x700	0,59	-	50	
	61022600	54x750	0,66	-	50	

KOVANO

KOSA KRANJSKA Z BRADO 70 SCYTHE CARNIOLA WITH BEARD 70
KRAINER BARTSENSE 70 FAUX 70

GESCHMIEDET	Art. No.	(a x b)			mm	
	61027000	70x400	0,40	-	50	
	61027100	70x500	0,55	-	50	
	61027200	70x550	0,60	-	50	
	61027300	70x600	0,65	-	50	
	61027400	70x650	0,70	-	50	
	61027500	70x700	0,72	-	50	

KOVANO

KOSA KRANJSKA BREZ BRADE 64 SCYTHE CARNIOLA WITHOUT B. 64
KRAINER SENSE OHNE BART 64 FAUX 64

GESCHMIEDET	Art. No.	(a x b)			mm	
	61025100	64x500	0,49	-	50	
	61025200	64x550	0,52	-	50	
	61025300	64x600	0,55	-	50	
	61025400	64x650	0,58	-	50	
	61025500	64x700	0,62	-	50	
	61025600	64x750	0,66	-	50	

KOVANO

KOSA BOSANSKA KOVANICA 40 BOSNIA SCYTHE 40
BOSNISCHE SENSE 40 FAUX 40

GESCHMIEDET	Art. No.	(a x b)			mm	
	61130200	40x700	0,41	-	50	
	61130300	40x750	0,45	-	50	
	61130400	40x800	0,49	-	50	
	61130500	40x850	0,53	-	50	

KOVANO

KOSA KRANJSKA BREZ BRADE 70 SCYTHE CARNIOLA WITHOUT B. 70
KRAINER SENSE OHNE BART 70 FAUX 70

GESCHMIEDET	Art. No.	(a x b)			mm	
	61026000	70x500	0,61	-	50	

KOVANO

KOSA GRŠKA GREEK SCYTHE
GRIECHISCHE SENSE FAUX

GESCHMIEDET	Art. No.	(a x b)			mm	
	61310000	45x500	0,32	-	50	
	61310100	45x550	0,35	-	50	
	61310200	45x600	0,39	-	50	
	61310300	45x650	0,40	-	50	
	61310400	45x700	0,45	-	50	
	61310500	45x750	0,48	-	50	
	61310600	45x800	0,52	-	50	

KOVANO

KOSA KRANJSKA Z BRADO 54 SCYTHE CARNIOLA WITH BEARD 54
KRAINER BARTSENSE 54 FAUX 54

GESCHMIEDET	Art. No.	(a x b)			mm	
	61024200	54x600	0,55	-	50	
	61024300	54x650	0,60	-	50	

KOVANO

KOSA TURŠKA OZKA TURKEY NARROW SCYTHE
TÜRKISCHE SCHMALE SENSE FAUX

GESCHMIEDET	Art. No.	(a x b)			mm	
	61180100	45x500	0,32	-	50	
	61180200	45x550	0,35	-	50	
	61180300	45x600	0,37	-	50	
	61180400	45x650	0,40	-	50	
	61180500	45x700	0,45	-	50	
	61180600	45x750	0,48	-	50	
	61180700	45x800	0,52	-	50	
	61180800	45x850	0,55	-	50	
	61180900	45x900	0,60	-	50	

KOVANO

KOSA NEMŠKA 50 GERMAN SCYTHE 50
DEUTSCHE SENSE 50 FAUX 50

GESCHMIEDET	Art. No.	(a x b)			mm	
	61060000	50x600	0,52	-	50	
	61060100	50x700	0,55	-	50	

KOVANO

KOSA NEMŠKA ID 1 Z LUK. 8.5 GERMAN SCYTHE ID 1 WITH HOLE 8,5
DEUTSCHE SENSE ID 1 MIT LOCH 8.5 FAUX ID 1

GESCHMIEDET	Art. No.	(a x b)			mm	
	61302100	60x600	0,51	-	50	
	61302200	60x650	0,56	-	50	
	61302300	60x700	0,61	-	50	
	61302400	60x750	0,76	-	50	
	61302500	60x800	0,80	-	50	

KOVANO

KOSA MODEL 61A 50 SCYTHE FORM 61A 50
HOCHRÜCKSENSE 61A 50 FAUX 61A 50

GESCHMIEDET	Art. No.	(a x b)			mm	
	61300100	50x600	0,55	-	50	
	61300200	50x650	0,60	-	50	
	61300300	50x700	0,65	-	50	

KOVANO

KOSA NEMŠKA OBLIKA 6 GERMAN SCYTHE FORM 6
DEUTSCHE SENSE FORM 6 FAUX 6

GESCHMIEDET	Art. No.	(a x b)			mm	
	61303100	70x450	0,41	-	50	
	61303200	70x500	0,46	-	50	
	61303300	70x550	0,51	-	50	
	61303400	70x600	0,56	-	50	
	61303500	70x650	0,61	-	50	
	61303600	70x700	0,66	-	50	

KOVANO

KOSA MODEL 61A 5 5 SCYTHE FORM 61A 55
HOCHRÜCKSENSE 61A 55 FAUX 61A 5

GESCHMIEDET	Art. No.	(a x b)			mm	
	61300500	55x670	0,70	-	50	

KOVANO

KOSA NEMŠKA S KRANJ. KONICO OBL. 7 GERMAN SCYTHE WITH POINT FORM 7
DEUTSCHE SENSE MIT STEINSPITZE FORM 7 FAUX 7

GESCHMIEDET	Art. No.	(a x b)			mm	
	61307100	60x600	0,54	-	50	
	61307200	60x650	0,57	-	50	
	61307300	60x700	0,60	-	50	
	61307400	60x750	0,63	-	50	

KOVANO

KOSA NEMŠKA ID GERMAN SCYTHE ID
DEUTSCHE SENSE ID FAUX ID

GESCHMIEDET	Art. No.	(a x b)			mm	
	61304600	60x700	0,55	-	50	
	61304700	70x750	0,65	-	50	

KOVANO

KOSA RESAVICA 65 HEATGRASS SCYTHE 65
HEIDESENSE 65 FAUX 65

GESCHMIEDET	Art. No.	(a x b)			mm	
	61040000	65x400	0,48	-	50	
	61040100	65x450	0,54	-	50	
	61040200	65x500	0,57	-	50	

KOVANO

KOSA NEMŠKA OBLIKA 7 GERMAN SCYTHE FORM 7
DEUTSCHE SENSE FORM 7 FAUX 7

GESCHMIEDET	Art. No.	(a x b)			mm	
	61301100	60x450	0,36	-	50	
	61301200	60x500	0,42	-	50	
	61301300	60x550	0,49	-	50	
	61301400	60x600	0,52	-	50	
	61301500	60x650	0,56	-	50	
	61301600	60x700	0,62	-	50	
	61301700	60x750	0,77	-	50	
	61301800	60x800	0,82	-	50	

KOVANO

KOSA RESAVICA 60 HEATGRASS SCYTHE 60
HEIDESENSE 60 FAUX 60

GESCHMIEDET	Art. No.	(a x b)			mm	
	61040300	60x550	0,57	-	50	

KOVANO

KOSA RESAVICA MODEL 123 HEIDESSENSE FORM 123 **HEATGRASS SCYTHE FORM 123 FAUX 123**

GESCHMIEDET	Art. No.	(a x b)			mm	
	6104 1000	80x400	0,60	-	50	
	6104 1100	80x450	0,76	-	50	
	6104 1200	80x500	0,80	-	50	

KOVANO

KOSA 70 SENSE 70 **SCYTHE 70 FAUX 70**

GESCHMIEDET	Art. No.	(a x b)			mm	
	6105 0200	70x600	0,60	-	50	
	6105 0300	70x650	0,70	-	50	

KOVANO

KOSA RESAVICA 80 HEIDESSENSE 80 **HEATGRASS SCYTHE 80 FAUX 80**

GESCHMIEDET	Art. No.	(a x b)			mm	
	6105 0000	80x400	0,50	-	50	
	6105 0100	80x500	0,60	-	50	

KOVANO

KOSA BELGIJSKA B1 55 BELGISCHE SENSE B1 55 **BELGIAN SCYTHE B1 55 FAUX B1 55**

GESCHMIEDET	Art. No.	(a x b)			mm	
	6137 0200	55x550	0,47	-	50	
	6137 0300	55x600	0,52	-	50	
	6137 0400	55x650	0,57	-	50	
	6137 0500	55x700	0,62	-	50	

KOVANO

KOSA RESAVICA B3 80 HEIDESSENSE B3 80 **HEATGRASS SCYTHE B3 80 FAUX B3 80**

GESCHMIEDET	Art. No.	(a x b)			mm	
	6104 6100	80x450	0,54	-	50	

KOVANO

KOSA BELGIJSKA B1 70 BELGISCHE SENSE B1 70 **BELGIAN SCYTHE B1 70 FAUX B1 70**

GESCHMIEDET	Art. No.	(a x b)			mm	
	6137 0600	70x550	0,50	-	50	
	6137 0700	70x600	0,55	-	50	
	6137 0800	70x650	0,61	-	50	
	6137 0900	70x700	0,68	-	50	

KOVANO

KOSA RESAVICA B3 85 HEIDESSENSE B3 85 **HEATGRASS SCYTHE B3 85 FAUX B3 85**

GESCHMIEDET	Art. No.	(a x b)			mm	
	6104 6000	85x400	0,48	-	50	

KOVANO

KOSA BELGIJSKA B2 55 BELGISCHE SENSE B2 55 **BELGIAN SCYTHE B2 55 FAUX B2 55**

GESCHMIEDET	Art. No.	(a x b)			mm	
	6137 1200	55x550	0,55	-	50	
	6137 1300	55x600	0,60	-	50	
	6137 1400	55x650	0,65	-	50	
	6137 1500	55x700	0,75	-	50	

KOVANO

KOSA RESAVICA B3 100 HEIDESSENSE B3 100 **HEATGRASS SCYTHE B3 100 FAUX B3 100**

GESCHMIEDET	Art. No.	(a x b)			mm	
	6104 6400	100x400	0,50	-	50	
	6104 6300	100x450	0,58	-	50	
	6104 6200	100x500	0,64	-	50	

KOVANO

KOSA BELGIJSKA B2 80 BELGISCHE SENSE B2 80 **BELGIAN SCYTHE B2 80 FAUX B2 80**

GESCHMIEDET	Art. No.	(a x b)			mm	
	6137 1600	80x550	0,60	-	50	
	6137 1700	80x600	0,65	-	50	
	6137 1800	80x650	0,70	-	50	
	6137 1900	80x700	0,75	-	50	

KOVANO

KOSA BOSANSKA KOVANICA 40 ŽILET BOSNIASCYTHE 40 ŽILET
BOSNISCHE SENSE 40 ŽILET FAUX 40 ŽILET

GESCHMIEDET	Art. No.	(a x b)			mm	
	61130205	40x700	0,41	-	50	
	61130305	40x750	0,45	-	50	
	61130405	40x800	0,49	-	50	
	61130505	40x850	0,53	-	50	

KOVANO

KOSA ANGLEŠKA 60 ENGLISH SCYTHE 60
ENGLISCHE SENSE 60 FAUX 60

GESCHMIEDET	Art. No.	(a x b)			mm	
	61345100	60x600	0,70	-	50	
	61345300	60x700	0,80	-	50	
	61345500	60x800	0,85	-	50	

KOVANO

KOSA KRANJSKA 55 ŽILET SCYTHE CARNIOLA 55 ŽILET
KRAINER SENSE 55 ŽILET FAUX 55 ŽILET

GESCHMIEDET	Art. No.	(a x b)			mm	
	61020905	55x500	0,48	-	50	
	61021105	55x600	0,52	-	50	
	61021205	55x650	0,54	-	50	
	61021305	55x700	0,58	-	50	
	61021405	55x750	0,62	-	50	

KOVANO

KOSA KANADSKA 55 CANADIAN SCYTHE 55
KANADISCHE SENSE 55 FAUX 55

GESCHMIEDET	Art. No.	(a x b)			mm	
	61340100	55x700	0,70	-	50	
	61340200	55x750	0,80	-	50	

KOVANO

KOSA ŠTAJERSKA 50 ŽILET SCYTHE STYRIA 50 ŽILET
STEIRISCHE SENSE 50 ŽILET FAUX 50 ŽILET

GESCHMIEDET	Art. No.	(a x b)			mm	
	61013105	50x600	0,48	-	50	
	61013205	50x650	0,51	-	50	
	61013305	50x700	0,55	-	50	
	61013405	50x750	0,58	-	50	
	61013505	50x800	0,60	-	50	

KOVANO

KOSA KANADSKA 70 CANADIAN SCYTHE 70
KANADISCHE SENSE 70 FAUX 70

GESCHMIEDET	Art. No.	(a x b)			mm	
	61343100	70x480	0,66	-	50	

KOVANO

KOSA VINOGRADNI ŠKA ŽILET VINEYARD SCYTHE ŽILET
WEINGARTENSENSE ŽILET FAUX

GESCHMIEDET	Art. No.	(a x b)			mm	
	61190005	50x450	0,29	-	50	

KOVANO

KOSA KANADSKA 50 CANADIAN SCYTHE 50
KANADISCHE SENSE 50 FAUX 50

GESCHMIEDET	Art. No.	(a x b)			mm	
	61341100	50x700	0,52	-	50	
	61341200	50x750	0,56	-	50	

KOVANO

KOSA VLAŠKA 45 ŽILET WALLACHIAN SCYTHE 45 ŽILET
WALLACHISCHE SENSE 45 ŽILET FAUX

GESCHMIEDET	Art. No.	(a x b)			mm	
	61310205	45x600	0,37	-	50	
	61310305	45x650	0,40	-	50	
	61310405	45x700	0,45	-	50	
	61010505	45x750	0,48	-	50	
	61010605	45x800	0,52	-	50	
	61010705	45x850	0,55	-	50	

KOVANO

KOSA KANADSKA 55 CANADIAN SCYTHE 55
KANADISCHE SENSE 55 FAUX 55

GESCHMIEDET	Art. No.	(a x b)			mm	
	61342100	55x700	0,79	-	50	
	61342200	55x750	0,83	-	50	

KOVANO

KOSA GOZDARSKA Z NOŽKOM FORSTKULTURSENSE		FORESTRY SCYTHE WITH KNIFE FAUX				
 <p>GESCHMIEDET</p> <p>KOVANO</p>	Art. No.	(a x b)				
	61045000	90x400	0,67	-	50	

KOSA ROČNA SENSENSICHEL MIT HOLZHEFT		GARDEN SCYTHE FAUX				
 <p>GESCHMIEDET</p> <p>KOVANO</p>	Art. No.	(a x b)				
	61230100	45x300	0,33	33x130	50	

KOSA MALA M516 KLEINSENSE M516		SMALL SCYTHE M516 FAUX M516				
 <p>GESCHMIEDET</p> <p>KOVANO</p>	Art. No.	(a x b)				
	61320000	55x400	0,35	-	50	

KOSA ROČNA - LEVA SENSENSICHEL MIT HOLZHEFT - LINKS		GARDEN SCYTHE - LEFT FAUX				
 <p>GESCHMIEDET</p> <p>KOVANO</p>	Art. No.	(a x b)				
	61238000	45x300	0,33	33x130	50	

KOSA CESTARSKA S TULJAVO IN PERESOM SENSE MIT FEDERDÜLLE		SCYTHE WITH SPOOL FAUX				
 <p>GESCHMIEDET</p> <p>KOVANO</p>	Art. No.	(a x b)				
	61500000	100x680	1,90	-	50	

KOSA ROČNA SENSENSICHEL SPECIAL		SPECIAL GARDEN SCYTHE FAUX				
 <p>GESCHMIEDET</p> <p>KOVANO</p>	Art. No.	(a x b)				
	61235000	45x315	0,25	-	50	

KOSA VINOGRADNIŠKA Z ROČAJEM WEINGARTENSENSE MIT STIEL		VINEYARD SCYTHE WITH HANDLE FAUX				
 <p>GESCHMIEDET</p> <p>KOVANO</p>	Art. No.	(a x b)				
	61400000	55x300	1,15	1500	50	

KOSNA KONICA SENSSENSPITZE		SCYTHE FAUX				
 <p>GESCHMIEDET</p> <p>KOVANO</p>	Art. No.	(a x b)				
	61330100	45x315	0,30	-	50	

KLEPEC DENGELHAMMER		SHARPEN HAMMER MARTEAU DE FAUX				
 <p>KOVANO</p>	Art. No.	(a x b)				
	69150000	130x30	0,60	250	50	

KOSIŠČE KOVINSKO SENSENBAUM METAL		METAL HANDLE FOR SCYTHE POIGNÉES EN MÉTAL DE FAUX				
	Art. No.	(a x b)				
	61710000	1500	1,35		5	

BABICA DENGELSTÖCKEL QUADRATISCH		MINI-ANVIL				
 <p>KOVANO</p>	Art. No.	(a x b)				
	69160000	120x35	0,54	-	50	

KOSIŠČE ŠTAJERSKO SENSENBAUM HOLZ		SCYTHE SNATH MANCHE EN BOIS DE FAUX				
 <p>FSC</p>	Art. No.	(a x b x l)				
	538011000	32x28x1550	1,50	Jesen	5	

VODIR WETZSTEINBECHER		MOUTING PLATER COFFIN				
	Art. No.	(a x b)				
	61600000	210x70	0,04	-	100	

KOSIR ENOJNI S KLJUČEM SENSENRING EINFACH MIT SCHLÜßEL		SCYTHES ATTACHMENTS ANNEAU DE FAUX				
	Art. No.	(a x b)				
	61250000	35x45x25	0,12	-	100	

KOSIR DVOJNI S KLJUČEM SENSENRING DOPPELT MIT SCHLÜßEL		SCYTHES ATTACHMENTS ANNEAU DE FAUX				
	Art. No.	(a x b)				
	61260000	35x45x50	0,18	-	100	

SRP TEMPO - LEVI **TEMPO SICKLE - LEFT**
RUND ODER BLATTSICHEL TEMPO - LINKS **FAUCILLE**



Art. No.	No.	(a x b)			
63011600	1	490x35	0,27	130	100
63011700	3	570x35	0,31	130	100

SRP TEMPO KOLENČAST - LEVI **TEMPO SICKLE BENT - LEFT**
SICHEL TEMPO GEKRÖPFT - LINKS **FAUCILLE**



Art. No.	No.	(a x b)			
63013300	0	430x35	0,25	130	100
63013400	1	470x35	0,27	130	100

SRP TEMPO **TEMPO SICKLE**
RUND ODER BLATTSICHEL TEMPO **FAUCILLE**



Art. No.	No.	(a x b)			
63010100	0000	380x35	0,20	130	100
63010200	000	400x35	0,22	130	100
63010300	00	430x35	0,24	130	100
63010400	0	450x35	0,25	130	100
63010600	1	490x35	0,27	130	100
63010800	2	530x35	0,29	130	100
63011000	3	570x35	0,31	130	100
63011200	4	610x35	0,33	130	100

SRP MATTEO **MATTEO SICKLE**
MATTEO SICHEL **FAUCILLE MATTEO**



Art. No.	No.	(a x b)			
63160100	1	450x35	0,30	365	80
63160200	2	480x35	0,35	365	80
63160300	3	520x35	0,40	365	80
63160400	4	570x35	0,45	365	80

SRP ROMUNSKI NAZOBCAN **ROMANIAN SICKLE TEETHED**
RUMÄNISCHE SICHEL GEZAHNT **FAUCILLE**



Art. No.	No.	(a x b)			
63040300	1	430x20	0,21	130	100
63040400	2	460x20	0,22	130	100

SRP CINO **CINO SICKLE**
CINO SICHEL **FAUCILLE CINO**



Art. No.	No.	(a x b)			
63170100	1	540x35	0,30	130	100

SRP SIBIRSKI NAZOBCAN **SIBERIAN SICKLE TEETHED**
SIBIRISCHE SICHEL GEZAHNT **FAUCILLE**



Art. No.	No.	(a x b)			
63030200	11	480x32	0,28	130	100

SRP BAČKA **BAČKA SICKLE**
BAČKA SICHEL **FAUCILLE BAČKA**



Art. No.	No.	(a x b)			
63020300	2	440x35	0,35	290	100

SRP TEMPO KOLENČAST **TEMPO SICKLE BENT**
SICHEL TEMPO GEKRÖPFT **FAUCILLE**



Art. No.	No.	(a x b)			
63012800	0	430x35	0,25	130	100
63012900	1	470x35	0,27	130	100

SRP GRŠKI NAZOBCAN **GREEK SICKLE TEETHED**
GRIECHISCHE SICHEL GEZAHNT **FAUCILLE**



Art. No.	No.	(a x b)			
63081500	3	530x32	0,30	130	100

SRP GRŠKI NAZOBČAN OZEK **GREEK SICKLE TEETHED NARROW**
GRIECHISCHE SICHEL GEZAHNT SCHMALL **FAUCILLE**

Art. No.	No.	(a x b)			
6308 0100	3	480x20	0,22	130	100
6308 0200	4	510x20	0,23	130	100
6308 0300	5	550x20	0,25	130	100
6308 0400	6	580x20	0,29	130	100
6308 0500	7	610x20	0,32	130	100
6308 0600	8	630x20	0,34	130	100
6308 0700	9	650x20	0,36	130	100
6308 0800	10	670x20	0,38	130	100
6308 0900	11	690x20	0,40	130	100
6308 1100	12	710x20	0,43	130	100

SRP GRŠKI EPIROS NAZOBČAN **GREEK EPIROS SICKLE TEETHED**
GRIECHISCHE SICHEL GEZAHNT EPIROS **FAUCILLE**

Art. No.	No.	(a x b)			
6308 2000	0	400x20	0,20	130	100
6308 2500	1	430x20	0,21	130	100
6308 3500	3	520x20	0,23	130	100

SRP GRŠKI CORFOU **GREEK CORFOU SICKLE**
GRIECHISCHE SICHEL CORFOU **FAUCILLE**

Art. No.	No.	(a x b)			
6308 4000	0	450x35	0,25	130	100
6308 5000	1	490x35	0,27	130	100
6308 6000	2	530x35	0,29	130	100

SRP KOLENČAST ANGLIJA **ENGLISH SICKLE BENT**
ENGLISCHE SICHEL GEKRÖPFT **FAUCILLE**

Art. No.	No.	(a x b)			
6331 0000		630x30	0,60	130	50

SRP GINOCCHIO C KOLENČAST **SICKLE GINOCCHIO C BENT**
GINOCCHIO SICHEL GEKRÖPFT **FAUCILLE GONOCCHIO C**

Art. No.	No.	(a x b)			
6319 0000	1	470x35	0,27	130	100

SRP SUD GLADEK **SUD SICKLE SMOOTHLY**
SUD SICHEL GLATT **FAUCILLE SUD**

Art. No.	No.	(a x b)			
6318 0100	0000	430x32	0,25	130	100
6318 0200	000	450x32	0,26	130	100
6318 0300	00	470x32	0,27	130	100
6318 0400	0	490x32	0,28	130	100
6318 0500	1	510x32	0,29	130	100
6318 0600	2	530x32	0,30	130	100
6318 0700	3	550x32	0,31	130	100
6318 0800	4	570x32	0,33	130	100

SRP REGGIO EMILIA D **REGGIO EMILIA D SICKLE**
REGGIO EMILIA D SICHEL **REGGIO EMILIA D FAUCILLE**

Art. No.	No.	(a x b)			
6325 0000	3	570x35	0,31	130	100

SRP SUD NAZOBČAN **SUD SICKLE TEETHED**
SUD SICHEL GEZAHNT **FAUCILLE SUD**

Art. No.	No.	(a x b)			
6318 1100	0000	430x32	0,25	130	100
6318 1200	000	450x32	0,26	130	100
6318 1300	00	470x32	0,27	130	100
6318 1400	0	490x32	0,28	130	100
6318 1500	1	510x32	0,29	130	100
6318 1600	2	530x32	0,30	130	100
6318 1700	3	550x32	0,31	130	100
6318 1800	4	570x32	0,33	130	100

SRP ORTO ZETA Z **ORTO ZETA Z SICKLE**
SICHEL ORTO ZETA Z **ORTO ZETA Z FAUCILLE**

Art. No.	No.	(a x b)			
6321 0000		220x30	0,11	110	100

SRP SUD NAZOBČAN IN KOLENČAST **SUD SICKLE TEETHED&BENT**
SUD SICHEL GEZAHNT UND GEKRÖPFT **FAUCILLE SUD**

Art. No.	No.	(a x b)			
6318 5000	0	460x32	0,28	130	100
6318 5100	1	480x32	0,29	130	100

SRP ZA RADIČ **SICKLE FOR CHICOKY**
SICHEL FÜR CHICORRE **FAUCILLE**

Art. No.	No.	(a x b)			
6326 0000		130x35	0,03	110	100

LOPATA HERKULES Z ROBOM **SPADE HERKULES**
SPATEN HERKULES MIT BÜGELTRITT **BECHÉ**



VALJANO GESCHMIEDET

Art. No.	(a x b)	Ⓜ	T/mm	mm	Ⓜ
6401 0000	295x240	1,40	-	-	10
6402 0000	295x240	2,25	T	890	5

LOPATA OKROGLA **RUND SHOVEL**
RUNDSCHAUFEL **PELLE**



VALJANO GESCHMIEDET

Art. No.	(a x b)	Ⓜ	T/mm	mm	Ⓜ
6405 0000	285x270	1,30	-	-	10
6407 0000	285x270	2,30	Q	1300	5

LOPATA HERKULES RAVNA **SPADE HERKULES**
SPATEN HERKULES GERADE **BECHÉ**



VALJANO GESCHMIEDET

Art. No.	(a x b)	Ⓜ	T/mm	mm	Ⓜ
6401 5000	290x200	1,30	-	-	10
6402 5000	290x200	2,30	T	890	5

LOPATA NEMŠKA **GERMAN SHOVEL**
DEUTSCHE SCHAUFEL **PELLE**



VALJANO GESCHMIEDET

Art. No.	(a x b)	Ⓜ	T/mm	mm	Ⓜ
6469 1000	300x265	1,40	-	-	10
6469 0000	310x275	1,60	-	-	10

LOPATA KONIČASTA **POINTED SHOVEL**
SPITZSCHAUFEL **PELLE**



VALJANO GESCHMIEDET

Art. No.	(a x b)	Ⓜ	T/mm	mm	Ⓜ
6404 0000	280x280	1,30	-	-	10
6406 0000	280x280	2,30	Q	1300	5

LOPATA RUDARSKA ŠIROKA **SOLID SOCKET SQUARE**
ENGLISCHE BREITSCHAUFEL **PELLE**



VALJANO GESCHMIEDET

Art. No.	(a x b)	Ⓜ	T/mm	mm	Ⓜ
6483 4000	320x250	1,90	-	-	10
6481 4100	305x245	2,50	T	700	5
6483 4100	320x250	2,45	T	700	5
6483 4300	320x250	2,65	Y	700	5
6483 4200	320x250	2,65	MY	700	5

LOPATA BAVARSKA - REBRO ZADAJ **BAVARIAN SAND SHOVEL**
BAYERISCHE SANDSCHAUFEL - RIPPE HINTEN **PELLE**



VALJANO GESCHMIEDET

Art. No.	No.	(a x b)	Ⓜ	T/mm	mm	Ⓜ
6408 0000		275x260	1,20	-	-	10
6460 1500	3	280x280	1,30	-	-	10
6461 1500	5	320x305	1,40	-	-	10
6460 0500	3	280x280	2,20	Q	1300	5
6461 0500	5	320x305	2,40	Q	1300	5

LOPATA RUDARSKA OZKA **SOLID SOCKET SHOVEL TAPER**
ENGLISCHE SCHMALSCHAUFEL **PELLE**



VALJANO GESCHMIEDET

Art. No.	(a x b)	Ⓜ	T/mm	mm	Ⓜ
6484 4000	320x250	1,90	-	-	10
6484 4100	320x250	2,40	T	700	5
6484 4300	320x250	2,60	Y	700	5
6484 4200	320x250	2,60	MY	700	5

LOPATA BAVARSKA - REBRO SPREDAJ **BAVARIAN SAND SHOVEL**
BAYERISCHE SANDSCHAUFEL - RIPPE OBEN **PELLE**



VALJANO GESCHMIEDET

Art. No.	No.	(a x b)	Ⓜ	T/mm	mm	Ⓜ
6460 1000	3	280x280	1,30	-	-	10
6461 1000	5	320x305	1,40	-	-	10
6460 0000	3	280x280	2,20	Q	1300	5
6461 0000	5	320x305	2,40	Q	1300	5

LOPATA RUDARSKA OKROGLA **SOLID SOCKET SHOVEL ROUND**
ENGLISCHE RUNDSCHAUFEL **PELLE**



VALJANO GESCHMIEDET

Art. No.	(a x b)	Ⓜ	T/mm	mm	Ⓜ
6485 4000	320x260	1,90	-	-	10
6482 4100	315x235	2,30	T	700	5
6485 4100	320x260	2,40	T	700	5
6485 4300	320x260	2,60	Y	700	5
6485 4200	320x260	2,60	MY	700	5

**LOPATA VRTNA VALJANA - HOBBY GARDEN SPADE - HOBY
HOBYSPATEN PELLE**

Art. No.	(a x b)				
64994200	250x155	1,20	-	10	



VALJANO GESCHMIEDET

**LOPATA VRT. VALJANA ZA DRENAŽO DRAINING GARDEN SPADE
DRAINAGESPATEN PELLE**

Art. No.	(a x b)				
64996001	320x135	1,50	-	10	
64996101	320x135	1,95	T 720	5	



VALJANO GESCHMIEDET

**LOPATA VRTNA VALJANA - HOLLAND GARDEN SPADE - HOLLAND
SPATEN - HOLLAND PELLE**

Art. No.	(a x b)				
64995500	280x165	1,60	-	10	
64995010	280x165	2,00	T 720	5	
64995003	280x165	2,00	T 780	5	



VALJANO GESCHMIEDET

**LOPATA VRT. VALJANA ZA DRENAŽO - ROB TREADED DRAINING
DRAINAGESPATEN MIT TRITT GARDEN SPADE**

Art. No.	(a x b)				
64996500	320x135	1,55	-	10	
64996600	320x135	2,15	T 780	5	



VALJANO GESCHMIEDET

**LOPATA VRT. VALJANA S PERESOM GARDEN SPADE
SPATEN MIT FEDERDÜLLE PELLE**

Art. No.	(a x b)				
64995200	280x165	2,20	T 780	5	



VALJANO GESCHMIEDET

**LOPATA SADILNA Z ROBOM TREADED POACHERS SPADE
PFLANZENSPATEN PELLE**

Art. No.	(a x b)				
64999000	265x120	1,30	-	10	



VALJANO GESCHMIEDET

**LOPATA VRT. VALJANA S PERESOM - ROB TREADED GARDEN SPADE
SPATEN MIT FEDERDÜLLE UND TRITT PELLE**

Art. No.	(a x b)				
64995600	280x165	2,20	T 780	5	



VALJANO GESCHMIEDET

**LOPATA DVOGLAVA SPATE SPECIALFORM
SPATEN SPEZIALFORM BECHE**

Art. No.	(a x b)				
64265000	290x170	2,10	T 720	5	



KALJENO GEHÄRTET

**LOPATA VRTNA VALJANA - VELIKA GARDEN SPADE - BIG
HOBYSPATEN - GROß PELLE**

Art. No.	(a x b)				
64994800	290x185	1,70	-	10	



VALJANO GESCHMIEDET

LOPATA ŠPIC - ITALIJA POINTED SHOVEL - ITALY
ITALIENISCHE SPITZSCHAUFEL ITALY PELLE



KALJENO GEHÄRTET

Art. No.	(a x b)				
6462 1000	230x215	0,80	-	10	
6463 1000	250x230	1,00	-	10	

LOPATA Z ROBOM - ITALIJA TREADED SHOVEL - ITALY
ITALIENISCHE SCHAUFEL MIT TRITT ITALY PELLE



KALJENO GEHÄRTET

Art. No.	(a x b)				
6468 0000	270x270	1,30	-	10	

LOPATA OKROGLA - ITALIJA ROUND SHOVEL - ITALY
ITALIENISCHE RUNDCHAUFEL ITALY PELLE



KALJENO GEHÄRTET

Art. No.	(a x b)				
6464 1000	230x225	0,98	-	10	

LOPATA KONIČASTA ALU POINTED SHOVEL ALU
SPITZSCHAUFEL ALU ITALY PELLE



KALJENO GEHÄRTET

Art. No.	(a x b)				
6468 1000	270x270	0,38	-	10	
6468 1500	270x270	1,30	1300	5	

LOPATA G OBLIKA - ITALIJA SHOVEL "G" - ITALY
ITALIENISCHE SCHAUFEL "G" ITALY PELLE



KALJENO GEHÄRTET

Art. No.	(a x b)				
6465 0000	220x160	0,70	-	10	

LOPATA PLOČEVINASTA OPEN SOCKET SHOVEL
BLECHSCHAUFEL ITALY PELLE



KALJENO GEHÄRTET

Art. No.	No.	(a x b)				
64109200	2	325x250	1,45	-	10	
64109400	4	280x280	1,60	-	10	
64109600	6	360x306	1,90	-	10	
64107200	2	325x250	1,90	Y	680	5
64107500	4	280x280	2,10	T	680	5
64107800	6	360x306	2,50	Q	1200	5

LOPATA "LOVRENC" - ITALIJA SHOVEL "LOVRENC" - ITALY
ITALIENISCHE SCHAUFEL "LOVRENC" ITALY PELLE



KALJENO GEHÄRTET

Art. No.	(a x b)				
6466 0000	210x160	0,80	-	10	

LOPATA BREZ ROBA - ITALIJA SHOVEL WITHOUT TREAD - ITALY
ITALIENISCHE SCHAUFEL OHNE TRITT ITALY PELLE



KALJENO GEHÄRTET

Art. No.	(a x b)				
6467 0000	275x225	1,10	-	10	

LOPATA VRTNA VELIKA Z ROBOM **GARDEN SPADE BIG**
GÄRTNERSPATEN GROß MIT TRITT **PELLE**

Art. No.	(a x b)	Weight	Blade		Quantity
			Material	Height (mm)	
64100000	280x180	2,07	T	935	5



KALJENO GEHÄRTET

LOPATA VRTNA Z DV. POD. PERESOM **GARDEN STRAPPED SPADE**
DOPPELFEDERSPATEN **PELLE**

Art. No.	(a x b)	Weight	Blade		Quantity
			Material	Height (mm)	
64235800	290x180	1,45	-	-	10
64236500	290x180	2,20	Q	1000	5
64235500	290x180	2,20	T	900	5
64235600	290x180	2,25	T	1000	5



KALJENO GEHÄRTET

LOPATA VRTNA MALA Z ROBOM **GARDEN SPADE SMALL**
GÄRTNERSPATEN KLEIN MIT TRITT **PELLE**

Art. No.	(a x b)	Weight	Blade		Quantity
			Material	Height (mm)	
64170100	250x160	1,54	T	915	5



KALJENO GEHÄRTET

LOPATA VRTNA BELGIJA 4-30 **GARDEN SPADE BELGIUM 4-30**
BELGISCHER SPATEN 4-30 **PELLE**

Art. No.	(a x b)	Weight	Blade		Quantity
			Material	Height (mm)	
64300800	265x165	1,25	-	-	10
64300000	265x165	2,00	Q	1000	5
64301000	265x165	1,90	T	900	5



KALJENO GEHÄRTET

LOPATA VRTNA - NORMAL **GARDEN SPADE - NORMAL**
GÄRTNERSPATEN **PELLE**

Art. No.	(a x b)	Weight	Blade		Quantity
			Material	Height (mm)	
64202000	250x160	0,84	-	-	10
64201000	250x160	1,62	Q	1000	5
64200000	250x160	1,54	T	900	5
64140800	280x180	1,34	-	-	10
64141000	280x180	2,17	Q	1000	5
64140000	280x180	2,07	T	900	5



KALJENO GEHÄRTET

LOPATA VRTNA BELGIJA 4-31 **GARDEN SPADE BELGIUM 4-31**
BELGISCHER SPATEN 4-31 **PELLE**

Art. No.	(a x b)	Weight	Blade		Quantity
			Material	Height (mm)	
64310800	300x160	1,32	-	-	10
64311000	300x160	2,15	Q	1000	5
64310000	300x160	2,05	T	900	5



KALJENO GEHÄRTET

LOPATA VRTNA - B **GARDEN SPADE - B**
BREMERSPATEN **PELLE**

Art. No.	(a x b)	Weight	Blade		Quantity
			Material	Height (mm)	
64220800	235x180	0,82	-	-	10
64221000	235x180	1,60	Q	1000	5
64220000	235x180	1,52	T	900	5
64162000	280x200	1,15	-	-	10
64161000	280x200	1,95	Q	1000	5
64160000	280x200	1,85	T	900	5



KALJENO GEHÄRTET

LOPATA VRTNA BELGIJA 4-32 **GARDEN SPADE BELGIUM 4-32**
BELGISCHER SPATEN 4-32 **PELLE**

Art. No.	(a x b)	Weight	Blade		Quantity
			Material	Height (mm)	
64320800	380x160	1,55	-	-	10
64321000	380x160	2,25	Q	1000	5
64320000	380x160	2,15	T	900	5



KALJENO GEHÄRTET

LOPATA VRTNA - G **GARDEN SPADE - G**
GEESTEMÜNDERSPATEN **PELLE**

Art. No.	(a x b)	Weight	Blade		Quantity
			Material	Height (mm)	
64212000	255x160	0,82	-	-	10
64211000	255x160	1,60	Q	1000	5
64210000	255x160	1,52	T	900	5
64152000	280x180	1,12	-	-	10
64151000	280x180	1,95	Q	1000	5
64150000	280x180	1,85	T	900	5



KALJENO GEHÄRTET

LOPATA VRTNA BELGIJA 4-33 **GARDEN SPADE BELGIUM 4-33**
BELGISCHER SPATEN 4-33 **PELLE**

Art. No.	(a x b)	Weight	Blade		Quantity
			Material	Height (mm)	
64330800	390x140	1,45	-	-	10
64331000	390x140	2,30	Q	1000	5
64330500	390x140	2,15	T	885	5



KALJENO GEHÄRTET

LOPATA VRTNA BELGIJA 4-34 GARDEN SPADE BELGIUM 4-34
BELGISCHER SPATEN 4-34 PELLE

Art. No.	(a x b)	mm	mm	mm	mm
6434 3000	290x175	1,20	-	10	
6434 0000	290x175	1,90	T 900	5	



KALJENO GEHÄRTET

LOPATA VRTNA BELGIJA 4-37 GARDEN SPADE BELGIUM 4-37
BELGISCHER SPATEN 4-37 PELLE

Art. No.	(a x b)	mm	mm	mm	mm
6437 0000	315x200	2,15	T 900	5	



KALJENO GEHÄRTET

LOPATA VRTNA S TULJAVO BELGIJA 4-34 GARDEN SPADE BELG. 4-34
BELGISCHER SPATEN MIT DÜLLE 4-34 PELLE

Art. No.	(a x b)	mm	mm	mm	mm
6434 0500	290x175	1,80	T 850	5	



KALJENO GEHÄRTET

LOPATA VRTNA BELGIJA 4-38 GARDEN SPADE BELG. 4-38
BELGISCHER SPATEN 4-38 PELLE

Art. No.	(a x b)	mm	mm	mm	mm
6438 0000	330x165	2,11	T 900	5	



KALJENO GEHÄRTET

LOPATA VRTNA BELGIJA 4-34 GARDEN SPADE BELGIUM 4-34
BELGISCHER GARTENSPATEN 4-34 PELLE

Art. No.	(a x b)	mm	mm	mm	mm
6434 1000	290x175	2,20	T 740	5	



KALJENO GEHÄRTET

LOPATA VRTNA S TULJAVO - NORMAL GARDEN SPADE - NORMAL
GÄRTNERSPATEN MIT DÜLLE PELLE

Art. No.	(a x b)	mm	mm	mm	mm
6492 0800	250x165	1,10	-	10	
6492 1000	250x165	1,80	Q 960	5	
6492 0000	250x165	1,80	T 860	5	
6490 0800	290x165	1,35	-	10	
6490 1000	290x165	2,00	Q 960	5	
6490 0000	290x165	1,85	T 860	5	



KALJENO GEHÄRTET

LOPATA VRTNA BELGIJA 4-35 GARDEN SPADE BELGIUM 4-35
BELGISCHER SPATEN 4-35 PELLE

Art. No.	(a x b)	mm	mm	mm	mm
6435 0500	260x155	1,15	-	10	
6435 1000	260x155	1,90	Q 1000	5	
6435 0000	260x155	1,85	T 900	5	



KALJENO GEHÄRTET

LOPATA VRTNA S TULJAVO - B GARDEN SPADE - B
BREMERSPATEN MIT DÜLLE PELLE

Art. No.	(a x b)	mm	mm	mm	mm
6495 0800	240x180	1,05	-	10	
6495 1000	240x180	1,80	Q 960	5	
6495 0000	240x180	1,75	T 860	5	
6494 1000	260x200	1,95	Q 960	5	
6494 0000	260x200	1,85	T 860	5	



KALJENO GEHÄRTET

LOPATA VRTNA BELGIJA 4-36 GARDEN SPADE BELGIUM 4-36
BELGISCHER GARTENSPATEN 4-36 PELLE

Art. No.	(a x b)	mm	mm	mm	mm
6436 0000	260x175	2,20	T 740	5	



KALJENO GEHÄRTET

LOPATA VRTNA S TULJAVO - G GARDEN SPADE - G
GEESTEMÜNDERSPATEN MIT DÜLLE PELLE

Art. No.	(a x b)	mm	mm	mm	mm
6497 0800	255x165	1,00	-	10	
6497 1000	255x165	1,70	Q 960	5	
6497 0000	255x165	1,70	T 860	5	
6496 1000	275x185	1,88	Q 960	5	
6496 0000	275x185	1,88	T 860	5	



KALJENO GEHÄRTET

LOPATA ALU 9 ALU SCHAUFEL NR.9 **ALUMINIUM SHOVEL NR. 9 PELLE ALUMINIUM**

Art. No.	(a x b)				
64105000	390x360	1,05	-	10	
64105200	390x360	2,00	Q 1300	5	

LOPATA ALU 2 ZLOŽLJIVA ALU SCHAUFEL NR.2 **ALUMINIUM FOLDING SHOVEL WITH HANDLE KLAPPSPATEN ALU MIT STIEL PELLE ALUMINIUM**

Art. No.	(a x b)				
64104210	250x305	1,15	700	5	

LOPATA ALU 7 ALU SCHAUFEL NR.7 **ALUMINIUM SHOVEL NR. 7 PELLE ALUMINIUM**

Art. No.	(a x b)				
64104900	325x340	0,95	-	10	
64105100	325x340	1,80	Q 1300	5	

LOPATA LESENA ZA SNEG HOLZSCHNEESCHIEBER **SNOW WOOD SHOVEL POUSSOIR A NEIGE BOIS**

Art. No.	(a x b)				
64103700	550x340	1,80	Q 1300	5	
64103800	500x350	1,70	Q 1300	5	

LOPATA ALU 8 ALU SCHAUFEL NR.8 **ALUMINIUM SHOVEL NR. 8 PELLE ALUMINIUM**

Art. No.	(a x b)				
64108300	370x325x2	1,40	Y 680	5	
64108400	370x325x3	1,70	Y 560	5	
64108500	370x325x3	1,80	T 680	5	

LOPATA LESENA OTROŠKA ZA SNEG KINDER-HOLZSCHNEESCHIEBER **SNOW WOOD SHOVEL-SMALL POUSSOIR A NEIGE BOIS**

Art. No.	(a x b)				
64103900	260x210	0,45	Q 800	5	

AVTOLOPATA ALU Z ROČAJEM ALU AUTOSCHAUFEL **ALUMINIUM SHOVEL PELLE AUTO DURAL**





Art. No.	(a x b)				
64104200	250x305	1,15	Y 685	5	





STRGALO ZA LED STOßSCHARRE **ICE SCRAPER GRATOIR**





Art. No.	(a x b)				
65621000	180x70	0,74	-	10	
65620000	180x70	1,58	Q 1100	5	





LOPATA ALU 2 ALU SCHAUFEL NR.2 **ALUMINIUM SHOVEL NR.2 PELLE ALUMINIUM**





Art. No.	(a x b)				
64104201	250x305	1,15	Y 685	5	
64104100	250x305	1,15	Y 730	5	

SEKIRA KRANJSKA KRAINISCHE AXT		CARNIOLA AXE HACHETTE					
	Art. No.	Kg	(a x b)				
	60185000	1,20	110x180	1,20	-	20	
	60186000	1,40	115x120	1,40	-	20	
	60187000	1,60	125x160	1,60	-	15	
	60188000	1,80	130x205	1,80	-	15	
	60189000	2,00	135x210	2,00	-	15	
	60195000	1,20	110x180	1,75	650	5	
	60196000	1,40	115x192	2,10	700	5	
	60197000	1,60	125x202	2,45	800	5	
	60198000	1,80	130x205	2,85	800	5	
60199000	2,00	135x210	3,05	900	5		





SEKIRA GRADBENA GERÜSTHACKE MIT NAGELZIEHER		BILDER 'S HACKET WITH NAIL PULLER HACHE					
	Art. No.	Kg	(a x b)				
	60121900	0,80	112x155	0,80	-	30	
	60122000	0,80	112x155	1,05	390	25	





SEKIRA UNIVERZALNA BAUMAXT		UNIVERZAL AXE HACHETTE					
	Art. No.	Kg	(a x b)				
	60126000	0,50	115x120	0,50	-	30	
	60128000	0,70	130x135	0,70	-	30	
	60130000	1,00	148x145	1,00	-	20	
	60140000	1,20	162x155	1,20	-	15	
	60150000	1,50	174x170	1,50	-	15	
	60160000	1,80	183x176	1,80	-	15	
	60170000	2,00	193x176	2,00	-	15	
	60127000	0,50	115x120	0,80	340	30	
	60129000	0,70	130x135	1,05	420	30	
	60135000	1,00	148x145	1,50	700	5	
	60145000	1,20	162x155	2,10	800	5	
	60156000	1,50	174x170	2,40	900	5	
	60166000	1,80	183x176	2,80	950	5	
	60176000	2,00	193x176	3,00	950	5	





SEKIRA TESARSKA ZIMMERMANSBEIL MIT NAGELZIEHER		CAMPENTER 'S HACKET WITH NAIL PULLER HACHETTE					
	Art. No.	Kg	(a x b)				
	60121100	0,80	107x175	0,80	-	30	
	60121200	0,80	107x175	1,05	400	25	





SEKIRA RENSKA RHEINISCHE AXT - DIN 7294		RHEIN AXE HACHE					
	Art. No.	Kg	(a x b)				
	60210000	1,00	118x180	1,00	-	25	
	60211000	1,25	124x195	1,25	-	25	
	60212000	1,40	130x200	1,40	-	25	
	60213000	1,60	135x205	1,60	-	25	
	60210500	1,00	118x180	1,50	600	5	
	60211500	1,25	124x195	1,90	700	5	
	60212500	1,40	130x200	2,05	700	5	
	60213500	1,60	135x205	2,40	800	5	

SUPER CEPILKA SUPER - SPALTAXT		WOOD SPLITTING AXE HACHE REFENDEUSE					
	Art. No.	Kg	(a x b)				
	60110300	1,10	90x150	1,10	-	30	
	60110100	2,00	90x193	2,00	-	20	
	60110400	1,10	90x150	1,60	500	5	
	60110200	2,00	90x193	2,80	800	5	
	SPECIAL						
60110405	1,10	90x150	1,60	500	5		
60110205	2,00	90x193	2,80	800	5		

SEKIRA GRŠKA GREICHISCHE AXT		AXE GREECE HACHE GREECE					
	Art. No.	Kg	(a x b)				
	60220000	0,60	115x160	0,60	-	50	
	60221000	0,85	125x175	0,85	-	50	
	60222000	1,00	128x185	1,00	-	25	
	60223000	1,25	132x198	1,25	-	25	
	60220500	0,60	115x160	1,10	700	5	
	60221500	0,85	125x175	1,75	800	5	
	60222500	1,00	128x185	1,90	800	5	
	60223500	1,25	132x198	2,10	900	5	

SUPER CEPILKA SUPER - SPALTAXT		WOOD SPLITTING AXE HACHE REFENDEUSE					
	Art. No.	Kg	(a x b)				
	60110500	1,70	100x160	1,70	-	20	
	60110600	1,70	100x160	2,40	700	5	
	SPECIAL						
60110605	1,70	100x160	2,40	700	5		

SEKIRA HIŠNA HAUSBEIL		HOME AXE HACHE					
	Art. No.	Kg	(a x b)				
	60120600	0,60	105x155	0,60	-	30	
	60120700	0,80	120x170	0,80	-	30	
	60121400	1,00	122x172	1,00	-	30	
	60120900	0,60	105x155	0,80	360	30	
	60121000	0,80	120x170	1,05	380	25	
	60121500	1,00	122x172	1,30	400	25	

BAT CEPILNI SPALTHAMMER		CLEAVER					
	Art. No.	kg	(a x b)				
	60110800	3,00	75x205	3,00	-	15	
	60110900	3,00	75x205	3,85	950	5	
	SPECIAL						
60110905			75x205		950	5	

CEPIN MALI Z ROČAJEM **PICK 0,60kg WITH HANDLE**
HANDSAPPIE MIT STIEL

Art. No.	Kg	(a x b)				
60230501	0,60	185x70	1,00	500	5	

KOVANO GESCHMIEDET

ZAGOZDE PVC **WEDGE PLASTIC**
KEILE PVC

Art. No.	Kg	(a x b)				
601001		40x30	0,01	-	100	
601002		44x35	0,01	-	100	
601003		50x35	0,01	-	100	
601004		52x40	0,01	-	100	
601005		57x40	0,01	-	100	
601006		61x40	0,01	-	100	
601007		65x40	0,01	-	100	

ZAGOZDE ZA SEKIRE IN KLADIVA KOVINSKE **WEDGE METALL**
METALLKEILE FÜR AXTE UND HÄMMER

Art. No.	Kg	(a x b)				
60101100			0,05		100	

SEKIRA GASILSKA **FIREMANS AXE**
FEUERWEHRHEIL **HACHETTE**

Art. No.	Kg	(a x b)				
60120800	0,80	82x198	0,80	-	400	
60121800	0,80	82x198	1,00	300	25	

KOVANO GESCHMIEDET

ZAGOZDE ZA SEKIRE KOVINSKE IN PVC **WEDGE METALL, PLASTIC**
KEILE FÜR AXTE UND HÄMMER PVC UND METALL

Art. No.	Kg	(a x b)				
60101000			0,05		50	

TESLO **ADZE**
FLACHE HACKE **PIOCHE**

Art. No.	Kg	(a x b)				
67321000	0,50	79x165	0,50	-	50	
67323000	0,60	81,5x175	0,60	-	50	
67322000	0,50	79x165	0,62	350	50	
67324000	0,60	81,5x175	0,72	350	50	

KOVANO GESCHMIEDET

TESLO GRŠKO **ADZE GREECE**
FLACHE GRIECHISCHE HACKE **PIOCHE GREECE**

Art. No.	Kg	(a x b)				
67325000	0,60	43,5x120	0,60	-	50	

KOVANO GESCHMIEDET

KRAMP NAVADEN KREUZHACKE		PICKAXE PIOCHE DE JARDIN				
	Art. No.	Kg	(a x b)			
	6740 0000	1,50	400x50	1,50	-	25
	6750 0000	1,75	450x50	1,75	-	25
	6751 0000	2,00	500x50	2,00	-	25
	6752 0000	2,25	475x50	2,25	-	25
	6753 0000	2,50	500x50	2,50	-	25
	6758 0000	3,00	550x55	3,00	-	15
	6758 1000	3,25	575x55	3,25	-	15
	6759 0000	3,50	600x55	3,50	-	15
	6740 5000	1,50	400x50	2,35	900	5
	6750 5000	1,75	450x50	2,60	900	5
	6751 5000	2,00	500x50	2,80	900	5
	6752 5000	2,25	475x50	3,15	900	5
6753 5000	2,50	500x50	3,40	900	5	

KLADIVO KROVSKO 12-01 LATHHAMMER		LATH HAMMER MARTEAU				
	Art. No.	(a x b)				
	6012 0100	165x30	0,85	300	25	

KRAMP KRIŽNI ASPHALTHACKE		MATTOCK CROSS SHISEL PIOCHE HACHE				
	Art. No.	Kg	(a x b)			
	6754 0000	0,70	250x45	0,70	-	25
	6755 0000	2,25	475x50	2,25	-	25
	6755 5000	2,25	475x50	3,15	900	5

SEKIRA ZIDARSKA 12-02 LATTBEIL		LATH AXE HACHETE				
	Art. No.	(a x b)				
	6012 0200	170x65x23	0,90	330	25	

KRAMP PODBIJAČ STOPSPITZHACKE		BEATER PICKAXE TEND DÉCINTROIR				
	Art. No.	Kg	(a x b)			
	6756 0000	3,00	540x65	3,00	-	20
	6757 0000	3,50	590x65	3,50	-	20
	6756 5000	3,00	540x65	3,90	900	5
	6757 5000	3,50	590x65	4,40	900	5

KLADIVO ZIDARSKO 12-03 MAURERHAMMER		MASONS HAMMER MARTELETTE				
	Art. No.	(a x b)				
	6012 0300	175x37	0,90	320	25	

KRAMP ZASEKAČ WURZELHACKE		ROOT PICK AXE				
	Art. No.	Kg	(a x b)			
	6759 6000	1,75	420x55	1,75	-	25
	6759 6100	1,75	420x55	2,70	900	5

KLADIVO ZIDARSKO 12-04 MAURERHAMMER MIT NAGELÖSE		MASONS HAMMER MARTELETTE				
	Art. No.	(a x b)				
	6012 0400	200x40x50	0,88	280	25	

DROG LOMILNI Z IN BREZ RAZCEPA BRECHSEISN		CROWBAR				
	Art. No.	i	(a x b)			
	6760 1300		900	6,00	-	5
	6760 1400		1100	8,00	-	5
	6760 1500		1200	10,00	-	5
	6760 1600		1300	12,00	-	5
	6760 0300		900	6,00	-	5
	6760 0400		1100	8,00	-	5
	6760 0500		1200	10,00	-	5
	6760 0600		1300	12,00	-	5

KLADIVO SEKAČ PFLASTERHAMMER		PAVING BEETLE MARTELETTE				
	Art. No.	(a x b)				
	6012 0500	330x55	1,90	175	80	

VEJNIK Z ROČAJEM **BILL HOOK SINGLE EDGE WITH HANDLE**
KULTURSICHEL MIT HEFT **SERPE**

Art. No.	(a x b)			
65110000	125x230	0,77	140	50

VEJNIK GOZDARSKI VELIKI **BILL HOOK FORESTRY DOUBLE EDGED**
KULTURSICHEL - GROß **SERPE**

Art. No.	(a x b)			
65655000	165x260	1,20	-	25
65650000	165x260	1,55	800	5

VEJNIK S TULJAVO **BILL HOOK SINGLE EDGE WITH SPOOL**
HEPPE MIT DÜLLE **SERPE**

Art. No.	(a x b)			
65100000	125x220	0,70	-	50

VEJNIK ADRIANO **BILL HOOK ADRIANO**
KULTURSICHEL ADRIANO **SERPE**

Art. No.	No.	(a x b)			
63280100	0	500x50	0,70	-	50
63280200	1	500x50	0,72	-	50

VEJNIK S TULJ. KLJUKA NAPREJ **BILL HOOK SINGLE EDGE WITH SPOOL**
HEPPE MIT DÜLLE **SERPE**

Art. No.	(a x b)			
65130000	125x220	0,80	-	50

NOŽ ZA SENO IN SLAMO **HAY CUTTER**
HEUTRETER

Art. No.	(a x b)			
65030000	230x780	1,89	-	5

VEJNIK S TULJ. KLJUKA NAZAJ **BILL HOOK SINGLE EDGE WITH SPOOL**
HEPPE MIT DÜLLE **SERPE**

Art. No.	(a x b)			
65140000	125x220	0,80	-	50

VEJNIK Z DVOJNIM REZILOM **BILL HOOK DOUBLE EDGED**
KULTURSICHEL MIT ZWEI SCHNEIDEN **SERPE**

Art. No.	(a x b)			
65170000	140x265	0,77	140	50

GRABLJE VRTNE GARTENRECHEN **GARDEN RAKE RÂTEAU DE JARDIN**

Art. No.	ZOB	(a x b)				
67110000	8	197x80x5	0,30	-	-	10
67120000	10	251x80x5	0,40	-	-	10
67130000	12	305x80x5	0,50	-	-	10
67140000	14	360x80x5	0,60	-	-	10
67190000	8	197x80x5	0,85	1500	-	5
67200000	10	251x80x5	0,95	1500	-	5
67210000	12	305x80x5	1,25	1500	-	5
67220000	14	360x80x5	1,35	1500	-	5

MOTIKA KOVANA RAVNA SCHUFFEL **FORGED HOE GRATTOIR**

Art. No.	(a x b)				
67381000	120x42	0,19	-	-	50
67382000	140x42	0,20	-	-	50
67383000	160x42	0,22	-	-	50
67384000	180x42	0,24	-	-	50
67385000	200x42	0,26	-	-	50

GRABLJE VRTNE GARTENRECHEN **GARDEN RAKE RÂTEAU DE JARDIN**

Art. No.	ZOB	(a x b)				
67150000	16	467x80x5	0,70	-	-	10
67170000	18	520x80x5	0,80	-	-	10
67230000	16	467x80x5	1,45	1500	-	5
67235000	18	520x80x5	1,55	1500	-	5

ČISTILEC TLAKOVCEV FUGENKRATZER **RIFT CLEANER**

Art. No.	(a x b)				
67250000	165x45x30	0,75	1500	-	5

GREBLJICA KOVANA KOTKRÜCKE GESCHMIEDET **FORGED RAKE RACLOIR**

Art. No.	(a x b)				
67280000	335x100	1,20	-	-	10
67285000	335x100	1,60	Q 1300	-	5

STRGALO VARJENO Z ROČAJEM SCHUFFEL **FORGED HOE GRATTOIR**

Art. No.	(a x b)				
65610000	450x140x43	0,30	130	-	50

GREBLJICA VIÑOGRADNIŠKA KOTKRÜCKE FÜR WEINGARTEN **RAKE FOR VINEYARD RACLOIR**

Art. No.	(a x b)				
67290000	1	200x80	0,46	-	50
67291000	2	250x80	0,50	-	50
67292000	3	300x80	0,56	-	50

MOTIKA KOVANA UPOGNJENA GESCHMIEDETE GARTENHÄCKE **FORGED BENDHOE RACLOIR**

Art. No.	(a x b)				
67370000	100x42	0,17	-	-	50
67371000	120x42	0,19	-	-	50
67372000	140x42	0,20	-	-	50
67373000	160x42	0,22	-	-	50
67374000	180x42	0,24	-	-	50
67375000	200x42	0,26	-	-	50
67376000	220x42	0,28	-	-	50

**MOTIČICA SRČASTA
SPITZE DOPPELHACKE**

**HOE DOUBLE POINTER
SERFOUETTE**



KOVANO GESCHMIEDET

Art. No.	(a x b)				
6735 0000	275x110	0,75	-	50	
6735 1000	275x110	0,95	510	5	
6735 2000	275x110	1,25	1300	5	

**KLIN SADILNI LESENI
PFLANZHOLZ**

**WOOD DIBBER
PLANTOIR**



Art. No.	(a x b)				
6234 0100	290x26	0,18	-	25	

**MOTIČICA OGLATA
FLACHE DOPPELHACKE**

**HOE DOUBLE
SERFOUETTE**

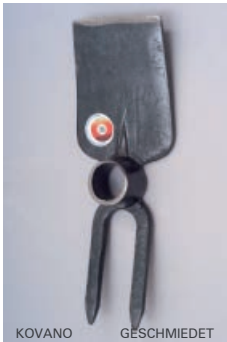

KOVANO GESCHMIEDET

Art. No.	(a x b)				
6736 0000	260x90	0,75	-	50	
6736 1000	260x90	0,95	510	5	
6736 2000	260x90	1,25	1300	5	

**MOTIČICA MALA Z ROČAJEM
KLEINHACKE**

**FLOWER HOE
SERFOUETTE**



Art. No.	(a x b)				
6703 0000	190x60	0,28	300	50	

**MOTIKA "DOLENJSKA"
HAUE "DOLENJSKA"**

**HOE "DOLENJSKA"
HOUE "DOLENJSKA"**



KOVANO GESCHMIEDET

Art. No.	(a x b)				
6732 0800	115x115	0,82	1200	5	

**ŠKARJE ZA TRTO
GARTENSCHERE**

**PRUNING SHEAR
SÉCATEUR**

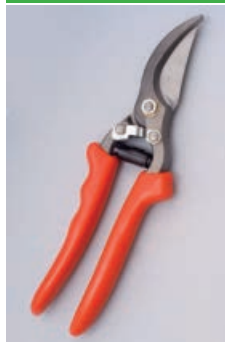

Art. No.	(a x b)				
6232 0000	225x65	0,35	-	100	

**KOPAČ ZA KROMPIR 2 R
KARTOFFELHACKE 2 ZINKEN**

**POTATOES CROCK 2 PRONGS
CROC A POMMES DE TERRE 2 DENTS**



Art. No.	(a x b)				
6739 5000	200x130	0,55	-	5	
6739 6000	200x130	1,20	1200	5	

**MOTIČICA VELIKA Z ROČAJEM
GARTENHAUE**

**GARDEN HOE
SERFOUETTE**



Art. No.	(a x b)				
6705 0000	220x100	0,59	1000	10	

ZAPIRALO DESNO SPERRKLINKE - RECHTS CLUTCH + HOOKS - RIGHT



Art. No.	(a x b)	Ⓜ	Ⓜ	↑mm	📦
69340000		0,42	-	100	
69390000		0,90	-	50	

ZAPIRALO LEVO SPERRKLINKE - LINKS CLUTCH - HOOKS LEFT



Art.No.	(a x b)	Ⓜ	Ⓜ	↑mm	📦
69370000		0,42	-	100	
69400000		0,90	-	50	

DRSNI OBROČ S SORNIKOM LASTHAKEN LOADING HOOKS



Art. No.	(a x b)	Ⓜ	Ⓜ	↑mm	📦
69420000	100x78	0,43	-	300	

DVOJNI PRST "BCS" - ODKOVEK DOUBBLE FINGER "BCS" DOPPELFINGER "BCS" - SCHMIEDETEIL



Art.No.	(a x b)	Ⓜ	Ⓜ	↑mm	📦
69139900	180x102	0,75	-	300	

DVOJNI PRST "GRAMIP" ODKOVEK DOUBBLE FINGER "GRAMIP" DOPPELFINGER "GRAMIP" SCHMIEDETEIL



Art. No.	(a x b)	Ⓜ	Ⓜ	↑mm	📦
69139800	180x102	0,75	-	300	

ODKOVKI SCHMIEDETEILE FORGINGS



Nudimo utopno kovanje odkovkov, od 0,5kg do 6kg. Obliko in kvaliteto prilagajamo željam kupcev.

Specialanfertigung von verschiedenen Schmiedeteilen, von 0,5kg bis 6kg, nach Kundenwunsch möglich!

We offer special forgings from 0,5kg to 6kg, according to customer specification.

ROČAJ ZA LOPATO HERKULES "T" HANDLE "T" FOR SPADE "HERKULES" STIEL "T" FÜR SPATEN "HERKULES"



Art. No.	i	(a x b x L)			
538015101		∅41x890	0,90	BUKEV	10

ROČAJ ZA SEKIRO KRANJSKO HANDLE FOR CARNIOLA AXE STIEL FÜR KRAINISCHE AXT



Art. No.	kg	(a x b x L)			
538051601	1,00	26x55x500	0,33	BUKEV	10
538052401	1,20	34x61x650	0,40	BUKEV	10
538052801	1,40	34x63x700	0,60	BUKEV	10
538053201	1,60	34x66x800	0,78	BUKEV	10
538053301	1,80	36x74x800	0,83	BUKEV	10
538053601	2,00	36x74x900	0,90	BUKEV	10

ROČAJ ZA LOPATO HERKULES "Q" HANDLE "Q" FOR SPADE "HERKULES" STIEL "Q" FÜR SPATEN "HERKULES"



Art. No.	i	(a x b x L)			
538016101		∅41x1020	0,90	BUKEV	10

ROČAJ ZA SEKIRO UNIVERZALNO HANDLE FOR UNIVERSAL AXE BEILSTIEL FÜR UNIVERSALAXT



Art. No.	kg	(a x b x L)			
538050501	0,50	27x46x340	0,28	BUKEV	10
538050401	0,70	30x47x420	0,35	BUKEV	10
538050301	1,00	34x55x700	0,70	BUKEV	10
538050001	1,20	39x60x800	0,77	BUKEV	10
538050101	1,50	35x58x900	0,80	BUKEV	10
538050201	1,80	34x59x950	0,98	BUKEV	10

ROČAJ ZA LOPATO METAČO PO DIN 20151 HANDLE FOR SHOVEL ACCORDING TO DIN 20151 SCHAUFELSTIEL NACH DIN 20151



Art. No.	i	(a x b x L)			
538017101		∅41x1300	0,98	BUKEV	25
538017001		∅41x1300	0,90	JESEN	25

ROČAJ ZA SEKIRO GRADBENO HANDLE FOR BUILDER'S HACHET STIEL FÜR GERÜSTHACKE



Art. No.	kg	(a x b x L)			
538055301	0,80	28x55x390	0,27	BUKEV	10
538055201	0,80	28x55x390	0,29	JESEN	10

ROČAJ ZA LOPATO VRTNO "T" HANDLE "T" FOR GARDEN SPADE STIEL "T" FÜR GARTENSPATEN



Art. No.	i	(a x b x L)			
538030101		∅39x915	0,88	BUKEV	10
538031101		∅41x935	0,85	BUKEV	10
538031001		∅41x935	0,85	JESEN	10

ROČAJ ZA SEKIRO HIŠNO HANDLE FOR HOME AXE STIEL FÜR HAUSBEIL



Art. No.	kg	(a x b x L)			
538056101	0,60	27x48x360	0,27	BUKEV	10
538056301	0,80	27x48x380	0,28	BUKEV	10
538056501	1,00	28x52x400	0,29	BUKEV	10

ROČAJ ZA LOPATO PLOČEVINASTO "PYD" STRAIGHT TAPER STIEL "PYD" FÜR BLECHSCHAUFEL "PYD GRIP" HANDLE



Art. No.	i	(a x b x L)			
538043200		∅36x685	0,42	BUKEV	10

ROČAJ ZA SUPER CEPILKO HANDLE FOR WOOD SPLITTING AXE STIEL FÜR SPALTAXT



Art. No.	kg	(a x b x L)			
538057801	1,10	32x64x500	0,45	JESEN	10
538057901	1,70	32x64x700	0,70	JESEN	10
538058001	2,00	34x66x800	0,80	JESEN	10

ROČAJ ZA KRAMP PICK-AXE HANDLE STIEL FÜR KREUZHACKE



Art. No.	kg	(a x b x L)			
538060601	2,00	36x62x900	0,70	BUKEV	10
538060101	2,50	41x74x900	0,95	BUKEV	10

ROČAJ ZA MOTIČICO KOVANO HANDLE FOR HOE STIEL FÜR HACKE

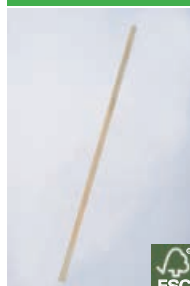

Art. No.	i	(a x b x L)			
538062001		∅32x510	0,28	BUKEV	10
538062101		∅32x1300	0,60	BUKEV	25

ROČAJ ZA MOTIKO ŠTAJERSKO HANDLE FOR HOE STYRIA
STIEL FÜR HAUE STEIRISCHE

Art. No.	i	(a x b x L)			
5380 66001		∅34x1300	0,60	BUKEV	25

ROČAJ ZA GRABLJE HANDLE FOR GARDEN RAKE
STIEL FÜR GARTENRECHEN

Art. No.	i	(a x b x L)			
5380 71701		∅28x1500	0,50	BUKEV	25
5380 71901		∅28x1700	0,60	BUKEV	25

ROČAJ ZA GREBLJICO HANDLE FOR RAKE
STIEL FÜR KOTKRÜCKE

Art. No.	i	(a x b x L)			
5380 73001		∅34x1300	0,70	BUKEV	10

ROČAJ ZA ROVNICO HANDLE FOR HOE
FORSTPFLANZEN - SETZHACKE

Art. No.	i	(a x b x L)			
5381 25101		35x37x1100	0,80	BUKEV	10

ROČAJ ZA MOTIČICO VRTNO HANDLE FOR GARDEN HOE
STIEL FÜR HACKE

Art. No.	i	(a x b x L)			
5381 20201		23x300	0,06	BUKEV	100
5380 71001		28x1000	0,32	BUKEV	25

ROČAJ ZA MACOLO - VELIKI SLEDGE HANDLE - BIG
SCHLEGELSTIEL - GROß

Art. No.		(a x b x L)			
5380 87601	3,00+4,00	44x34x800	0,60	BUKEV	10
5380 91101	5,00+6,00	54x35x800	0,60	JESEN	10
5380 9130	8,00+6,00	56x35x900	0,90	JESEN	10

ROČAJ ZA TESLO HANDLE FOR ADZE
STIEL FÜR FLACHE HACKE

Art. No.	i	(a x b x L)			
5380 62501		∅35x350	0,20	BUKEV	100

ROČAJ ZA MACOLO - MALI SLEDGE HANDLE - SMALL
SCHLEGELSTIEL - KLEIN

Art. No.		(a x b x L)			
5380 87001	2,00	28x39x300	0,14	BUKEV	150

ROČAJ ZA KLADIVO HAMMER HANDLE
HAMMERSTIEL

Art. No.		(a x b x L)			
5380 85201	0,25 + 0,30	21x29x300	0,08	BUKEV	150
5380 85301	0,50	24x34x320	0,09	BUKEV	150
5380 85401	0,60	26x36x330	0,10	BUKEV	150
5380 85501	0,80	28x38x350	0,12	BUKEV	150
5380 85601	1,00	29x39x360	0,14	BUKEV	100
5380 85701	1,25 + 1,50	30x40x380	0,17	BUKEV	100
5380 85801	3,00	31x42x400	0,20	BUKEV	100

ROČAJ ZA BAT CEPILNI CLEAVER HANDLE
SPALTHAMMERSTIEL

Art. No.		(a x b x L)			
5380 83101	3,00	46x52x950	0,85	BUKEV	10

ROČAJ ZA SRP TEMPO HANDLE FOR SICKLE TEMPO
STIEL FÜR SICHEL TEMPO

Art. No.	i	(a x b x L)			
5380 05501		∅33x130	0,05	BUKEV	300

ROČAJ ZA PILO HANDLE FOR FILE
STIEL FÜR FEILE

Art. No.	i	(a x b x L)			
5380 93001		∅22x80	0,03	BUKEV	300
5380 93101		∅24x100	0,04	BUKEV	300
5380 93201		∅26,5x120	0,05	BUKEV	300

BRIKETI LESNI WOOD BRIQUETTES
HOLZBRIKETTS

Art. No.	(a x b)			
6010 5000	∅ 80x300	1,67	BUKEV / JESEN	10kg

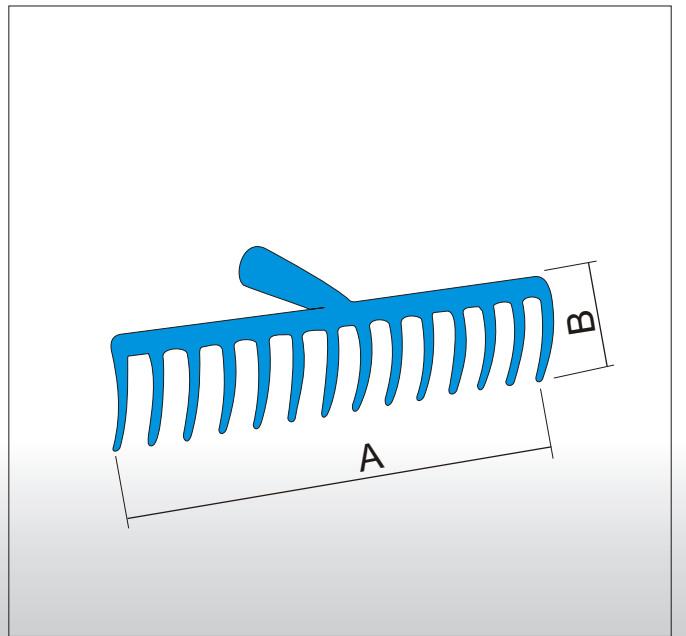
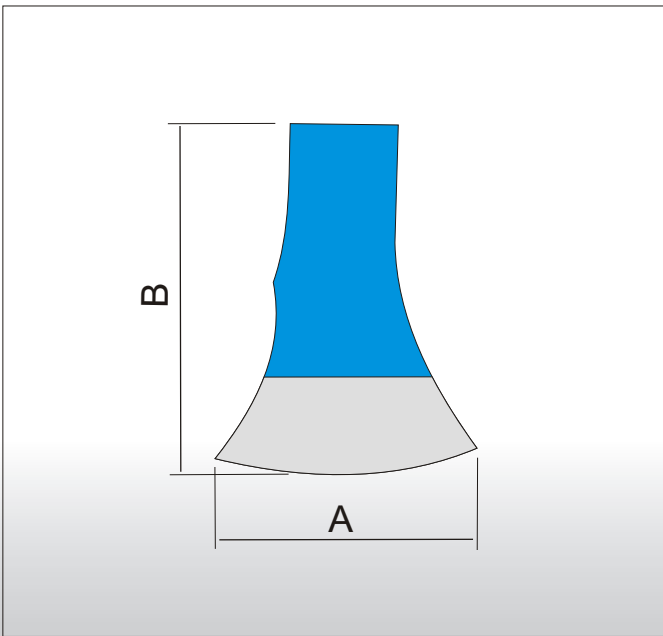
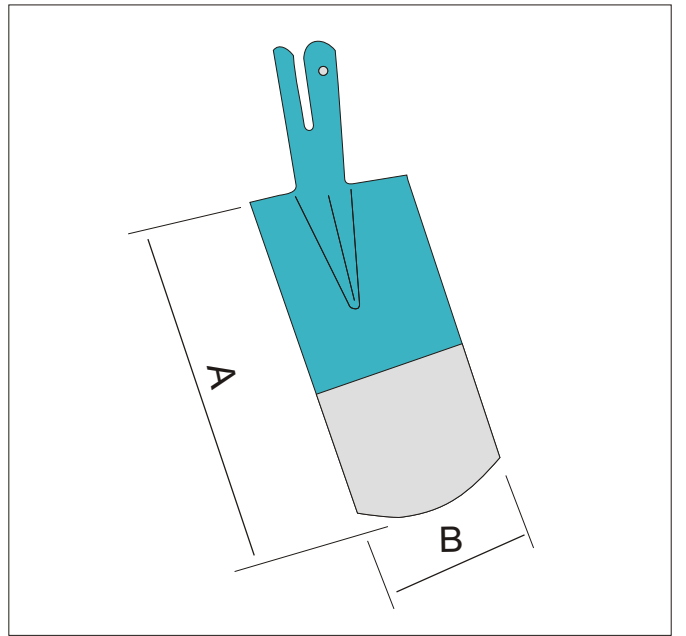
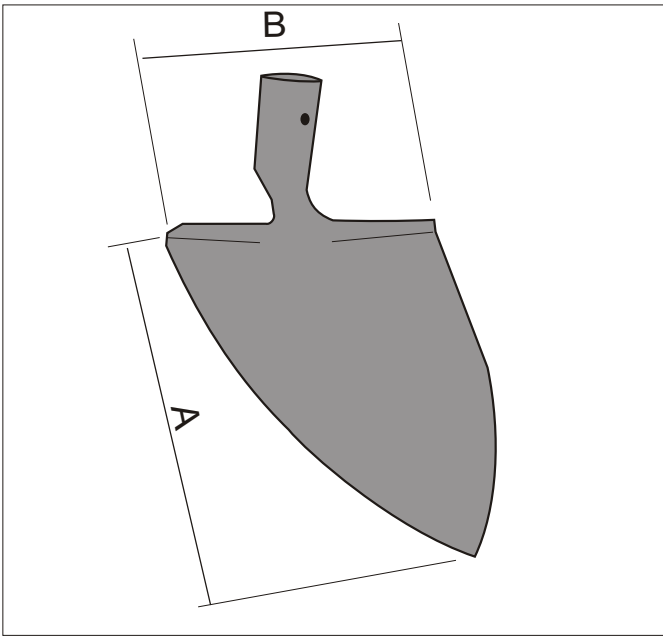
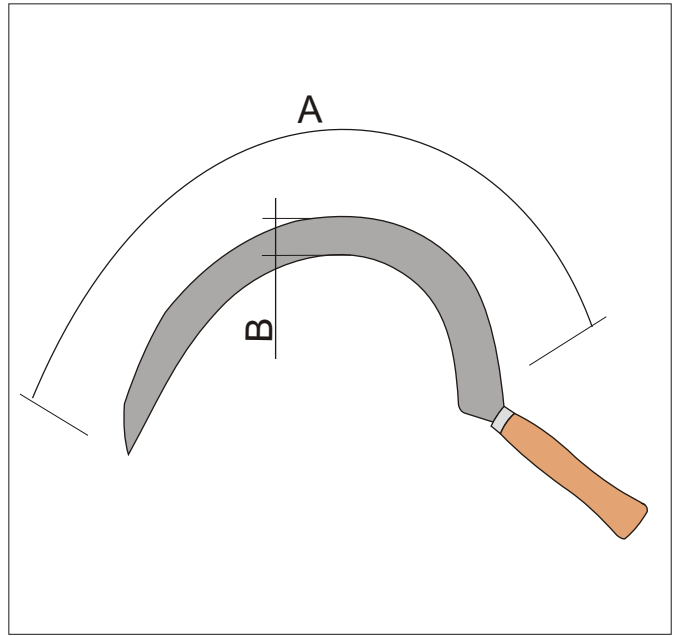
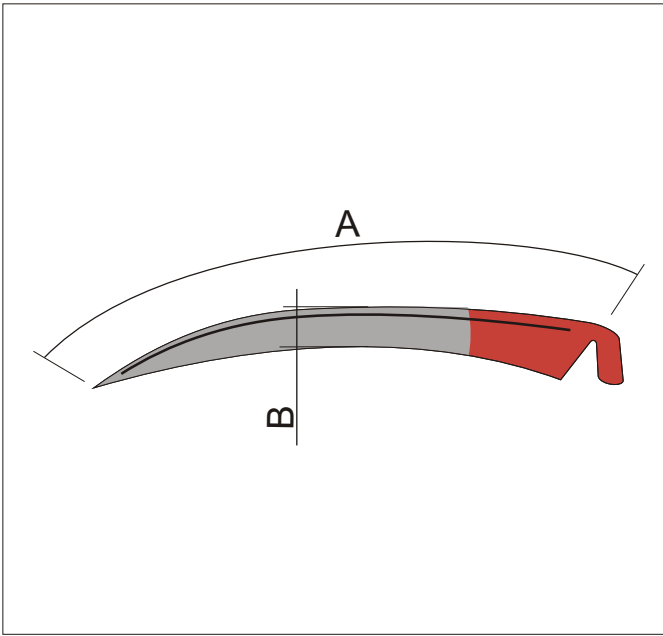

STRUC TOVARNA KOS IN SRPOV d.o.o.
A COMPANY OF STRUC HOLDING

Kovaška cesta 100
Lovrenc na Pohorju 2344
Slovenija

Telefon h.c.: +386 (0)2 67 19 826
Telefax: +386 (0)2 67 19 809

E-Mail: tk@struc.info
Internet: www.struc-holding.com

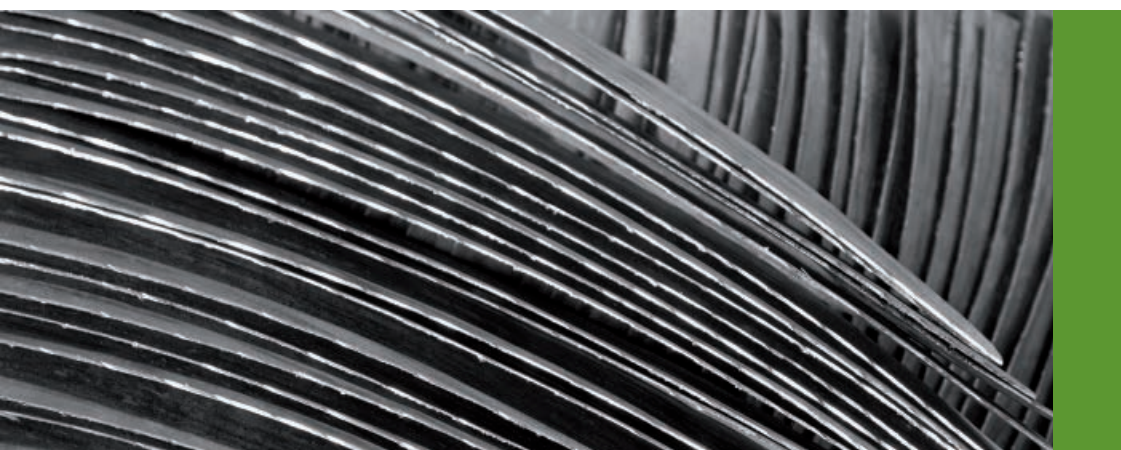

STRUC Tovarna kos in srpov d.o.o.

www.struc-holding.com

Auf www.struc-holding.com können Sie sich ein umfangreiches Bild über unsere Produktbereiche machen.

Have a look at www.struc-holding.com to see our wide range of products.

Na spletni strani www.struc-holding.com si lahko ogledate široki program naših izdelkov.

STRUC Holding



- STRUC Tovarna kos in srpov d.o.o.
- STRUC Kovačija Muta d.o.o.
- STRUC MUTA, kmetijska mehanizacija d.o.o.
- Bukev d.o.o.
- STRUC Tokos d.o.o.
- STRUC Ekoing d.o.o.

STRUC  since 1881
**TOVARNA KOS
IN SRPOV**

- STRUC Tovarna kos in srpov d.o.o.
- Tel. h.c. +386 (0)2 6719-826
Fax +386 (0)2 6719-809
E-Mail: tk@struc.info
www.struc-holding.com